

SERVICE MANUAL

MODEL 2002 MONITOR

PN-314986-01

 **commodore**
COMPUTERS

SERVICE MANUAL

MODEL 2002 MONITOR

PN-314986-01

Commodore-Amiga, Inc.

1200 Wilson Drive, West Chester, Pennsylvania 19380 U.S.A.

Commodore-Amiga Inc. makes no expressed or implied warranties with regard to the information contained herein. The information is made available solely on an as is basis, and the entire risk as to quality and accuracy is with the user. Commodore-Amiga Inc. shall not be liable for any consequential or incidental damages in connection with the use of the information contained herein. The listing of any available replacement part herein does not constitute in any case a recommendation, warranty or guaranty as to quality or suitability of such replacement part. Reproduction or use without expressed permission, of editorial or pictorial content, in any matter is prohibited.

This manual contains copyrighted and proprietary information. No part of this publication may be reproduced, stored in a retrieval system, or transmitted in any form or by any means, electronic, mechanical, photocopying, recording or otherwise, without the prior written permission of Commodore-Amiga Inc.

Copyright © 1985 by Commodore-Amiga Inc.
All rights reserved.

CONTENTS

IMPORTANT SERVICE SAFETY INFORMATION	2
SPECIFICATIONS	3
INSTALLATION AND CHASSIS PARTS LOCATION	4
SERVICE INSTRUCTIONS	6
SERVICE ADJUSTMENT	9
SERVICE INFORMATION	15
P.C. BOARD LAYOUTS	16
CIRCUIT DIAGRAM	21
BLOCK DIAGRAM	23
PARTS LIST	24

AVERTISSEMENT POUR S'ÊTRE ASSURÉ D'UNE SÉCURITÉ OPTIMALE À TOUT MOMENT, REMPLACEZ LES COMPOSANTS DÉFECTUEUX EN UTILISANT SEULEMENT DES PIÈCES RECOMMANDÉES PAR LE FABRICANT DE L'APPAREIL. CES PIÈCES SONT IDENTIFIÉES PAR UNE ZONE D'OMBRÉ ET PAR LE SYMBOLE "A" SUR LE SCHÉMA DE MONTAGE.

The manufacturer's safety and health will be void if any unauthorized modifications or alterations are made to the equipment. Use the type of specified type of wire and cable, ensuring that the positioning of the wire is followed as shown in the wiring diagram. Use of alternative wiring or positioning could result in damage to the set or a shock or fire hazard. The active line used in the monitor employs special insulation protection and should be treated with the same type of care as a normal line. When handling the CRT, avoid sharp edges and wear protective clothing. Do not touch the CRT glass or the back of the monitor.

WARNING: BEFORE RETURNING THE MONITOR TO THE CUSTOMER PERFORM THE FOLLOWING SAFETY CHECKS IN ITEMS 1, 2 AND 3 FOR THE CONTINUED SAFETY OF THE SERVICEMAN AND CUSTOMER.

1. Leakage Current Test
 Plug the AC power cord directly into a 120V AC outlet. Do not use an extension cord for this test.
 Use a Leakage Current Tester or a testing meter which complies with the following specifications: IUL 515, IUL 501 or CSA 1003.1 No. 107-735 B.
 Measure the current flowing from all exposed metal parts of the cabinet, including the top cover, handle, bezel, wooden cabinet, etc. Lead wires must be terminated, capped and fastened to the ground pin of an AC outlet or to a known ground.
 The leakage test should be performed with the AC switch OFF and repeated with the AC switch ON. The measured current must be less than 0.5 mA.
 Any measurement out with the limits outlined above are indicative of a potential shock hazard and corrective action must be taken before returning the instrument to the customer.

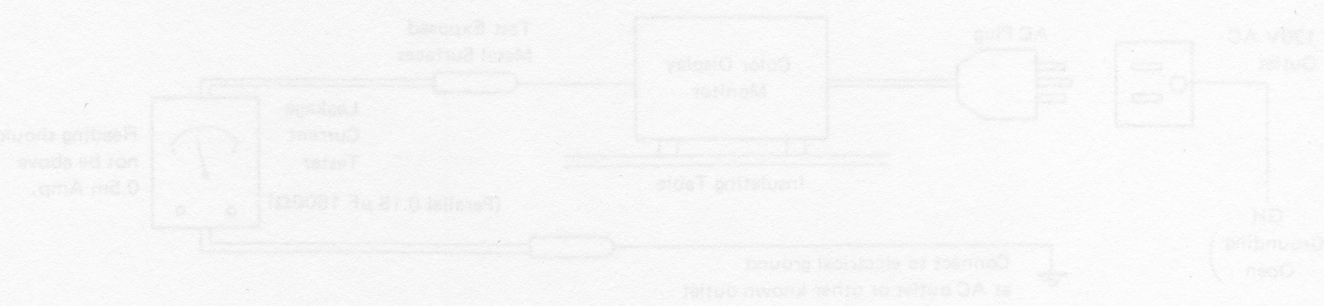

2. Resistance Test
 With the AC plug removed from the 120V AC outlet, place a jumper across the two attachment plug wiring except grounding for 1/4 in. the white GND. Using an ohmmeter, connect one lead to the grounded AC plug and the other lead to each exposed wire (not terminal) and to an exposed metal part. The resistance measured should not be less than 1.0 megohm or greater than 0.5 megohms. Any resistance value below or above this range indicates an abnormality which requires corrective action.
 Repeat the test with the AC switch in the OFF position.

3. Wire Revision
 In case of removing Wire Clamp during service, make sure to return Clamp and Wiring loose to original position after servicing.

1. SPECIFICATIONS

CRT	13V inch 90° in-line, 0.41 or 0.42mm slot pitch, gray face, high resolution	Video band width	RGBI: 15 MHz Analog RGB: 10 MHz Video: 4.2 MHz
Input signals	Digital RGBI, Analog RGB, NTSC Composite, Separated video (luma & chroma) and Audio	Scanning frequency	Horizontal: 15.75 kHz Vertical: 60 Hz
Input level	Digital RGBI: TTL Analog RGB: Video 0.7 Vp-p/75Ω Sync. TTL Comp., Video, Chroma: 1Vp-p/75Ω	Audio	Input: 1Vp-p/20KΩ Output: 1.2W
Display size	233 (h) x 180 (v) mm	Dimensions	360(W) x 376(D) x 327.5(H) cm
Colors	RGBI: 16 colors Analog RGB: Full colors Comp.: Full colors	Weight	Approx. 12 kg
Resolution	RGB: 2,000 characters (80 column x 25 lines) Comp.: 1,000 characters (40 column x 25 lines)	Power input	120 VAC, 60 Hz, 1A
		Power consumption	72W

* Design, features and specifications are subject to change without notice.

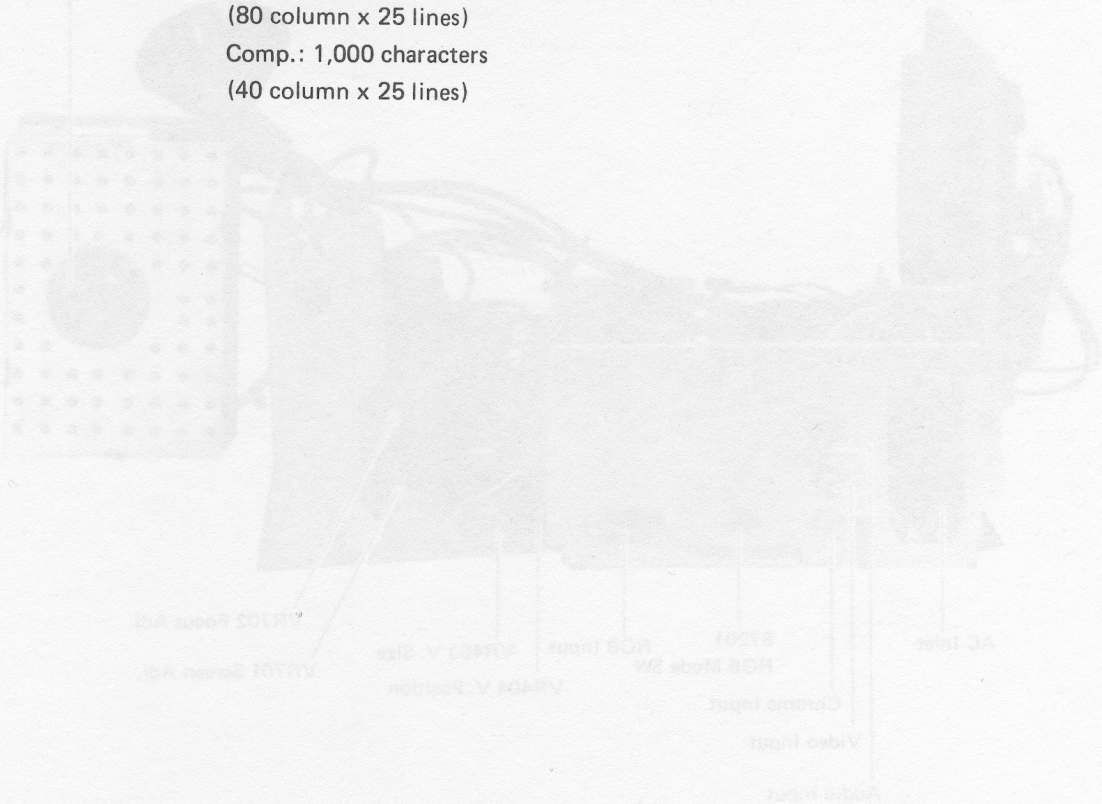

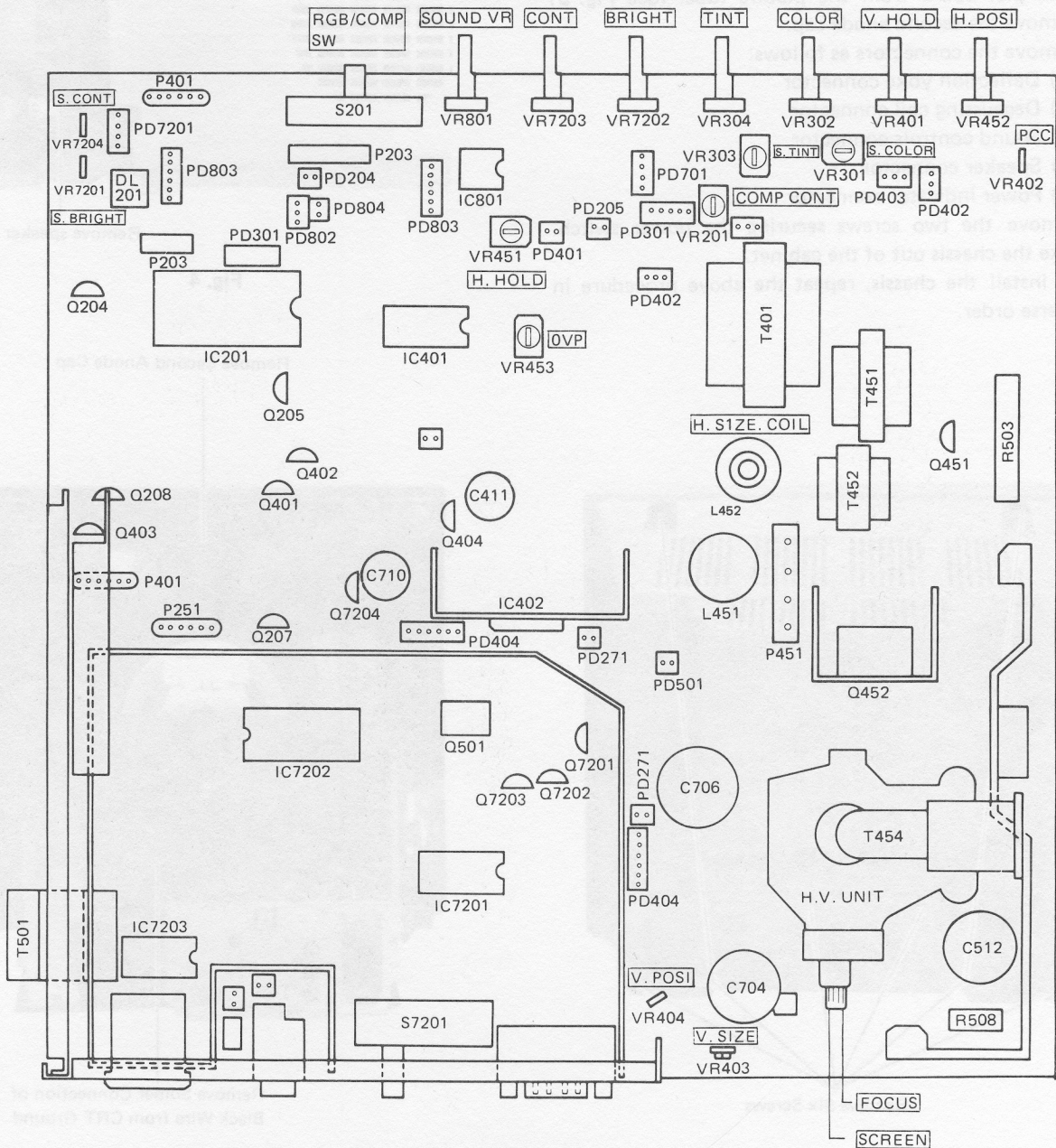
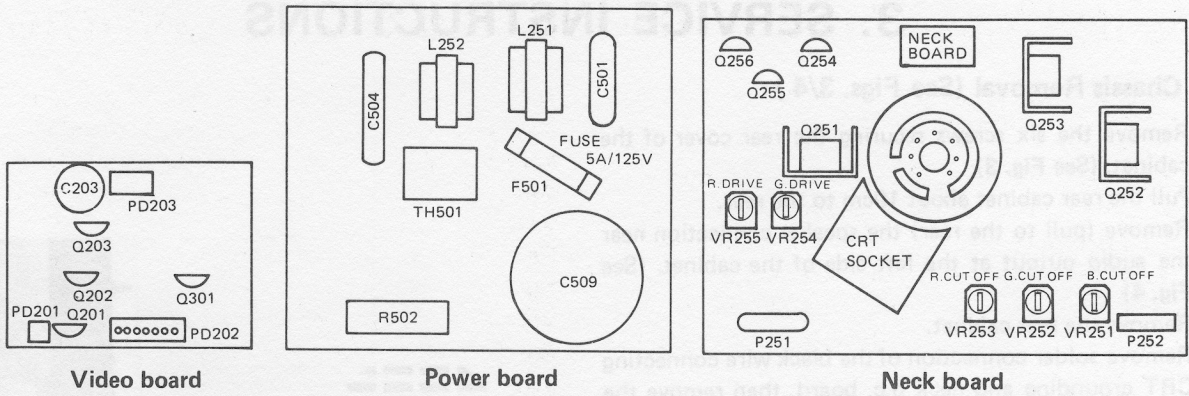

Fig. 2

3. SERVICE INSTRUCTIONS

3.1 Chassis Removal (See Figs. 3/4)

1. Remove the six screws securing the rear cover of the cabinet. (See Fig. 3)
2. Pull the rear cabinet about 10cm to the rear.
3. Remove (pull to the rear) the speaker connection near the audio output at the left side of the cabinet. (See Fig. 4)
4. Remove the rear cabinet.
5. Remove solder connection of the black wire connecting CRT grounding and neck p.c. board, then remove the neck p.c. board from the picture tube. (See Fig. 5)
6. Remove the second anode cap.
7. Remove the connectors as follows:
 - 1) Deflection yoke connector
 - 2) Degaussing coil connector
 - 3) Sound controls connector
 - 4) Speaker connector
 - 5) Power indicator connector
8. Remove the two screws securing the power switch.
9. Take the chassis out of the cabinet.
10. To install the chassis, repeat the above procedure in reverse order.

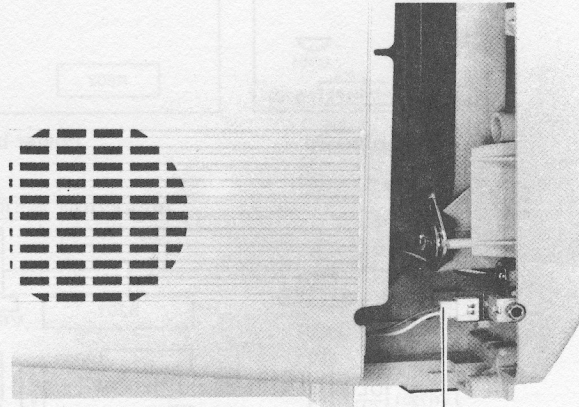
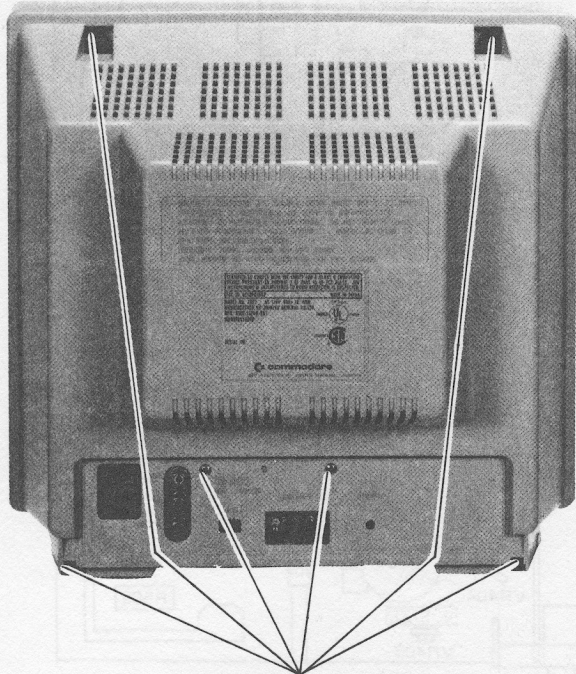
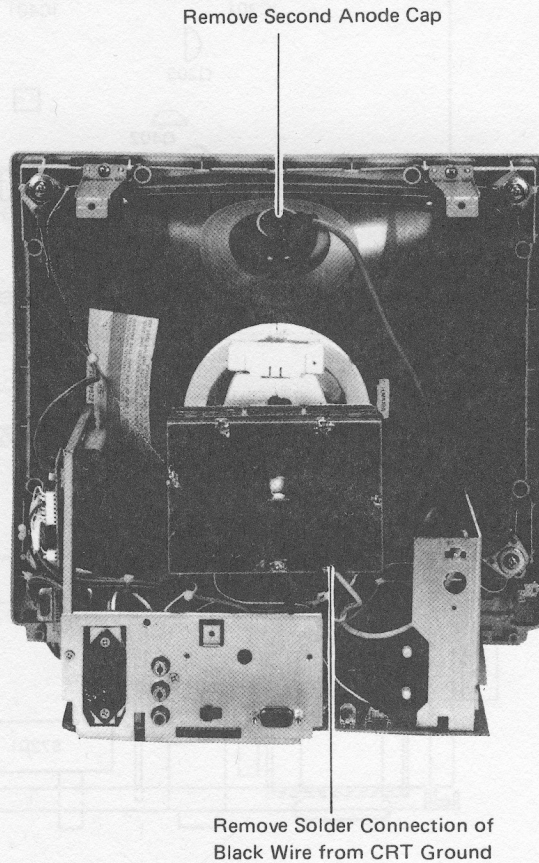

Fig. 4



Remove Six Screws

Fig. 3



Remove Second Anode Cap

Remove Solder Connection of Black Wire from CRT Ground

Fig. 5

3.2 Main Chassis Servicing

1. Remove the rear cabinet.
2. Repairing of main chassis can be done easily, if stood as shown in Fig. 6.

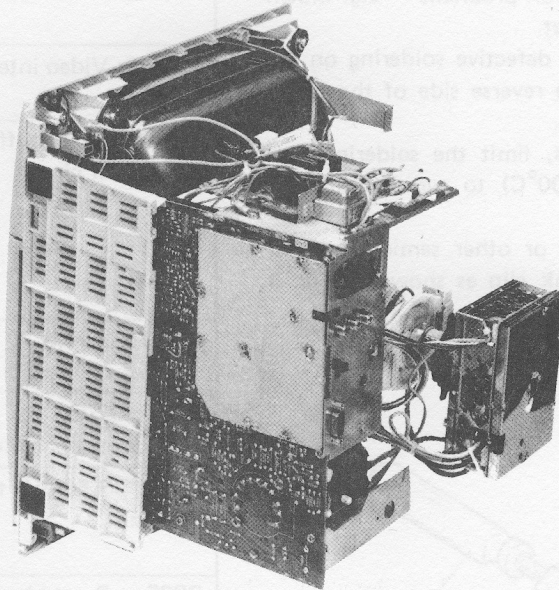

Fig. 6

3.3 Picture Tube Removal

In order to remove or replace the picture tube, the chassis must first be removed. Refer to Chassis Removal procedure. After the chassis has been removed, proceed as follows.

1. Loosen the clamping screws on the deflection yoke, purity and static convergence magnet, and remove them.
2. Remove four screws securing the picture tube to the front cabinet.

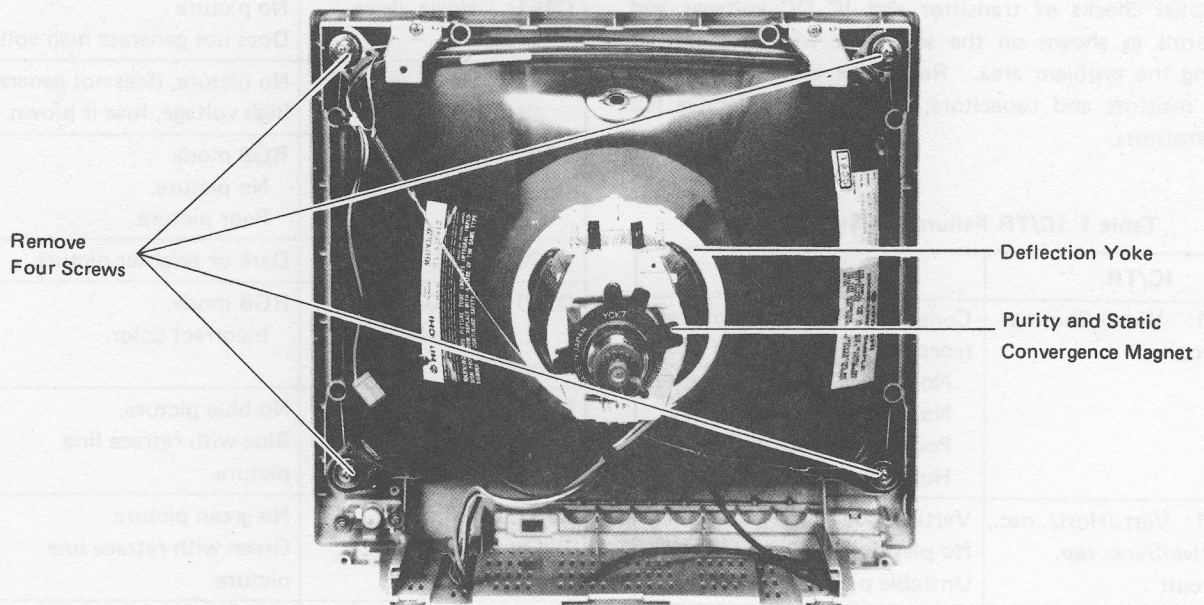

Fig. 7

3.4 Precautions for Repairs

1. Check for bad contacts on connectors on the main PC board and elsewhere by applying hand pressure.
2. Check AC power supply for problems — e.g. blown fuse, bad switch or AC outlet.
3. Check for intermittents or defective soldering on the main board by striking the reverse side of the board gently with an insulated bar.
4. When soldering PC boards, limit the soldering iron temperature to 500°F (200°C) to avoid peeling of the foil.
5. When soldering transistors or other semiconductors, use tweezers or a heat sink clip as shown in Fig. 8 to prevent heat damage.

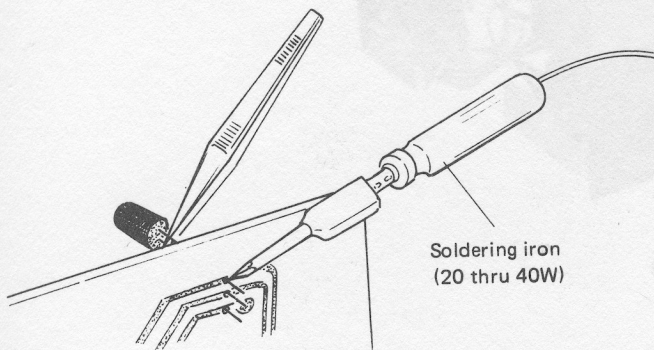

Fig. 8

3.5 Troubleshooting

As major parts of this chassis employ ICs, defects can often be isolated by referring to the table of symptoms in Table 1.

Additional checks of transistor and IC DC voltages and waveforms as shown on the schematic will assist in pinpointing the problem area. Remember also to check for faulty resistors and capacitors, etc. around defective ICs and transistors.

Table 1 IC/TR Failure and Symptoms

IC/TR	SYMPTOM
IC201: Video Chroma circuit	Composite/Separate — mode reception No picture and poor picture. No color and monochrome. Poor color synchronization. Hue discrepancy.
IC401: Vert./Horiz. osc., Drive/Sync. sep. circuit	Vertical line only. No picture, No high voltage. Unstable picture.
IC402: Vert. output circuit	Horizontal line only. Poor vertical scan.

IC/TR	SYMPTOM
IC501: A.V.R. circuit	Humpered picture.
IC7201: RGBI Interface circuit	RGBI Mode reception. No picture. No color or incorrect color.
IC7202: Video interface circuit	No picture or poor picture. Incorrect color.
IC7203: Sync. buffer, Inverter circuit	RGB Mode reception Unstable picture. No picture RGB mode and Composite/ Separate mode reception does not select.
IC801: Audio amp. circuit	No sound or poor sound
Q201~Q203: Video amp. circuit	Composite/Separate mode No picture or poor picture.
Q204: 3.58MHz trap. circuit	Composite mode Small dotted stripes appear in the picture.
Q205: Burst blanking circuit	Composite/Separate mode Incorrect color (White balance not uniform)
Q207, Q208: Gate pulse circuit	Dark picture or no picture
Q301: Chroma amp. circuit	Composite/Separate mode No color or incorrect color.
Q401~Q403: Vert sync. amp. circuit	Unstable vertical picture.
Q404: Vertical position circuit	Incorrect vertical picture position.
Q451: Horiz. drive circuit	No picture Does not generate high voltage.
Q452: Horiz. output circuit	No picture, does not generate high voltage, fuse is blown.
Q501: +5V Regulator	RGB mode No picture. Poor picture.
Q7204: ABL circuit	Dark or brighter picture.
Q7201~Q7203: R.G.B. buffer circuit	RGB mode. Incorrect color.
Q251, Q254: Blue output circuit	No blue picture. Blue with retrace line picture.
Q252, Q255: Green output circuit	No green picture. Green with retrace line picture.
Q253, Q256: Red output circuit	No. red picture. Red with retrace line picture.

3.6 Desoldering of ICs and TR

The following tools are suggested for desoldering semiconductors:

1. Desoldering tools
 - a) Hand suction type — Solda-Pullit[®] (model SS011, Edsyn Inc., Van Nuys, CA.) or equivalent.
 - b) Wire-Wick type — Solder-Wick[®] (size #4, Solder Removal Co., Covina, CA) or equivalent.

2. Soldering Iron — Maximum wattage recommended is 40W. Higher power soldering irons may damage the copper foil of board.

Note:

When desoldering parts, heat the joint and remove the solder quickly. The PC foil may peel from the board if heat is applied for too long.

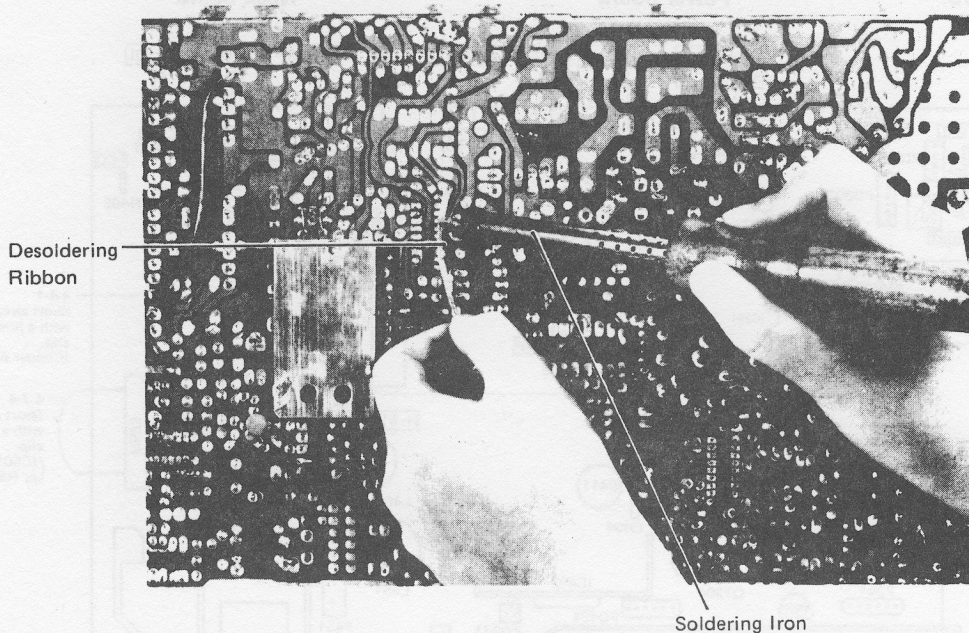

Fig. 9

4. SERVICE ADJUSTMENT

4.1 Focus Adjustment

Adjust the focus control, located on the H.V. unit (T454) for maximum overall definition and fine picture detail with brightness and contrast controls set at normal viewing levels.

4.2 Vertical Size (VR403) Adjustment

The vertical size (height) control is the screwdriver adjustment that is accessible through the rear cover.

Location of the control is shown in Figs. 1 and 10.

These controls must be adjusted until the correct picture or test pattern is obtained.

4.3 Circuit Protection

A 5.0A pigtail fuse, mounted on the main PC board, has been provided to protect the power output circuit. See Figs. 2 and 10.

4.4 Horizontal Hold (VR451) Adjustment (See Figs. 1 and 10)

Receive the color signal.

Set the brightness and contrast controls to a normal position. A warm-up period of at least five minutes should be allowed and alignment should be done.

1. Short circuit IC401 (13) and (14) with a jumper clip. See Fig. 10.
2. Short circuit IC7202 (12) and (13) with a jumper clip. See Fig. 10.
3. Adjust the horiz. hold control (VR451) until the picture is stable. (Tune VR451 to 15.734 kHz). After adjustment, remove the clips.

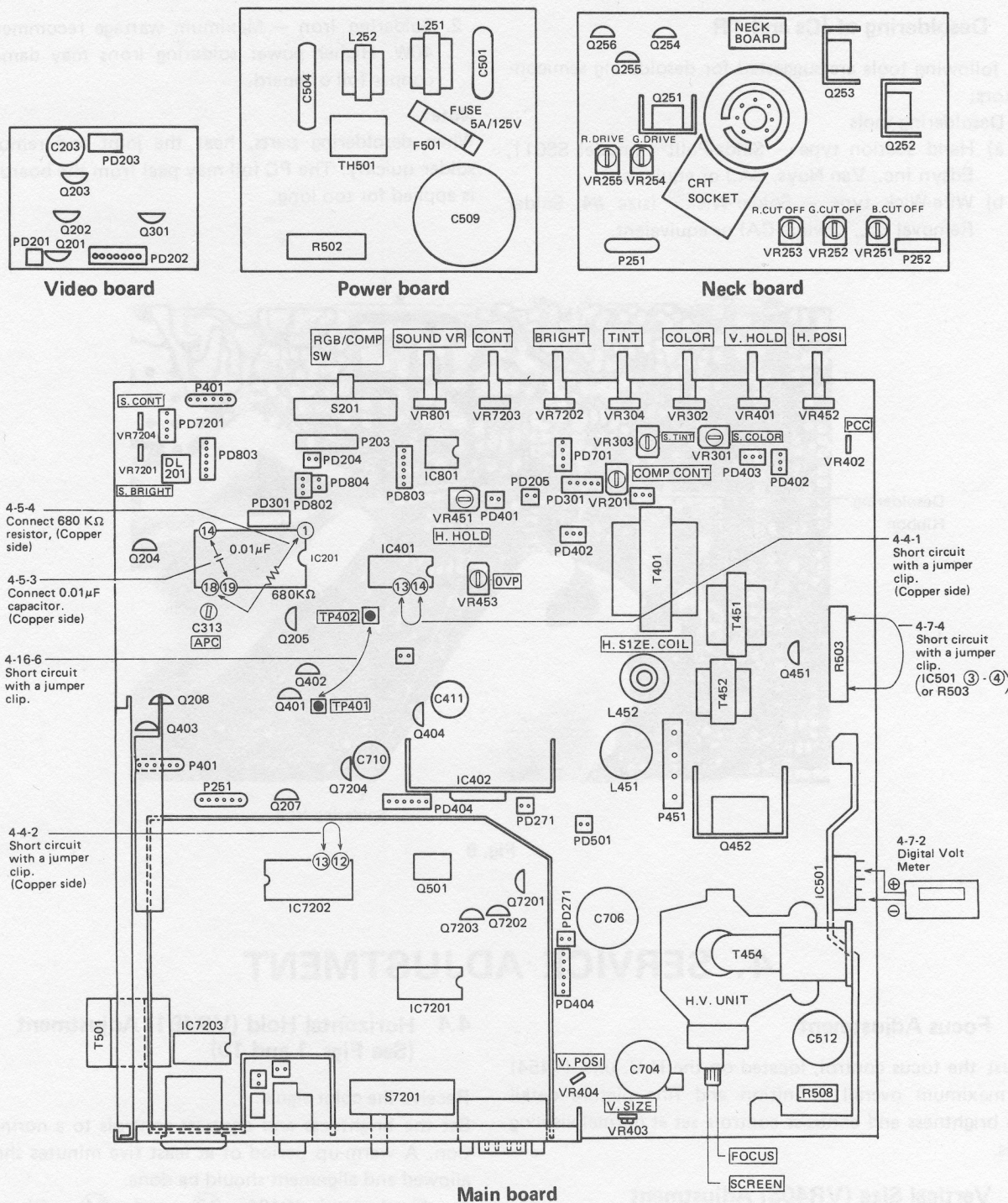

Fig. 10

4.5 APC Adjustment (See Fig. 10)

This adjustment should be made only when the chroma/video IC (IC201) or parts of the APC circuit have been replaced, or when the picture colors are unstable. For adjustment, use the APC ADJ. control (C313).

Procedures:

1. Apply a color bar signal to the video input terminal.
2. Turn the color control fully clockwise and position the tint control at the mechanical center.
3. Connect a jumper clip between IC201 (19) and chassis ground through 0.01 μ F capacitor.
4. Connect a jumper clip between IC201 (1) and (18) through 680 k Ω resistor.
5. Turn the APC ADJ. control (C313) with an insulated screwdriver until the color bar on the screen is synchronized.
6. Remove the jumper clips.

4.6 High Voltage Check

High voltage is not adjustable but must be checked to verify that the monitor is operating within safe and efficient design limitations as specified:

1. Remove cabinet back.
2. Operate monitor for at least 15 minutes at 120V AC line with video signal or test signal properly tuned in.
3. Rotate the brightness and contrast controls to maximum clockwise position.
4. Connect an accurate high voltage meter to CRT anode. Reading should be between 22.5 kV and 25 kV.

4.7 Over Voltage Protector Control (VR453) Adjustment (See Fig. 10)

The over voltage protector control (VR453) is factory adjusted and sealed with epoxy glue.

However, if readjustment should be required, proceed as follows.

1. Operate the receiver for at least 5 minutes at 120V AC Line.
2. Connect the positive lead of digital volt-meter to IC501, pin 4 (+123V DC line), negative lead to hot chassis ground.
3. Maximize the brightness and contrast controls and put the O.V.P. adj. control in the fully counterclockwise position.
4. Short circuit pin ③ and pin ④ of IC501 with a jumper clip.
5. Adjust the AC line voltage for a digital voltmeter reading of 135V DC.
6. Turn the over voltage protector control slowly clockwise, and set it to the point at which the picture disappears.
7. After adjustment, VR453 must be sealed with epoxy glue.

NOTE:

Readjust the overvoltage protector control (VR453) in the following case:

When parts, marked "★" as X-ray relative critical components in the connection diagram and parts list, are replaced.

4.8 Vertical Position Control (VR404) Adjustment (See Fig. 10)

The vertical position control (VR404) is the VR which controls the vertical position of the picture.

If the vertical position of the picture is not at the center of the picture tube, adjust the vertical position by turning this control.

4.6 Contrôle de Haute Tension

La haute tension n'est pas réglable mais doit être contrôlée afin de s'assurer que le moniteur fonctionne d'une mesure de sécurité et d'efficacité déterminée par le cahier des charges. Pour le faire:

1. Enlever le couvercle d'arrière du cabinet.
2. Faire fonctionner le moniteur pendant au moins 15 minutes à la ligne de 120V, C.A. en accordant correctement le signal de vidéo ou celui d'essai.
3. Tourner à fond les commandes de brillance et de contraste dans le sens des aiguilles d'une montre.
4. Brancher un voltmètre de haute précision sur l'anode de CRT. La valeur relevée doit être comprise entre 22,5 kV et 25 kV.

4.7 Commande de protection contre la surtension (VR453) Réglage (Voir la fig. 10.)

La commande de protection contre la surtension (VR 453) a été réglée dans l'usine et fermée hermétiquement avec la colle d'époxy.

Toutefois, lorsqu'il faut le régler de nouveau, procéder d'une façon suivante.

1. Faire fonctionner le récepteur pendant au moins 15 minutes à la ligne de 120V, C.A.
2. Raccorder le conducteur positif du voltmètre digital à IC501, branche 4 (ligne de +123V, C.C.) et le conducteur négatif à la masse du châssis chaud.
3. Mettre les commandes de brillance et de contraste au maximum et tourner la commande de réglage O.V.P. au sens anti-horaire jusqu'au fond.
4. Mettre la branche ③ et la branche ④ d'IC501 en court circuit en se servant d'un clip de pont.
5. Régler la tension de la ligne de C.A. afin d'avoir une lecture du voltmètre digital de 135V, C.C.
6. Tourner doucement la commande de protection contre la surtension au sens horaire, et l'amener au point donc l'image disparaisse.
7. Après le réglage, fermer hermétiquement le VR453 avec la colle d'époxy.

NOTE:

Régler de nouveau la commande de protection de survoltage (VR453) lorsque des cas suivants se présentent:

Lorsqu'on remplace des pièces marquées par "★" telles que les composants critiques relatifs aux rayons X mentionnés sur le diagramme de connexions et sur la liste de pièces.

4.9 Horizontal Size Adjusting Coil (L452) (See Fig. 10)

This is the horizontal size adjusting coil. It is adjusted at the factory.

When the horizontal size readjustment is required, turn the core of L452 with a hexagonal adjusting bar.

4.10 Composite Contrast Control (VR201) Adjustment

This is the composite contrast level adjustment control. It is adjusted at the factory.

When readjustment is required, proceed as follows:

1. Receive the composite video signal, such as H characters pattern.
2. Set the contrast, brightness, Color and Tint controls at the mechanical center position.
3. Adjust the composite contrast control so that normal contrast is obtained.

4.11 Sub Color (VR301), Sub Tint (VR303) Control Adjustment

These controls are adjusted at the factory.

When readjustment is required, proceed as follows:

1. Receive the color bar signal (Composite/Separate mode).
2. Set the contrast, brightness, Color and Tint controls at the mechanical center position.
3. Adjust the sub color and sub tint controls so that normal color is obtained.

4.12 Sub Brightness (VR7201) and Sub Contrast (VR7204) Controls Adjustment

These controls are adjusted at the factory.

When readjustment is required, proceed as follows:

1. Receive H characters pattern at RGB mode.
2. Set the contrast and brightness controls at the mechanical center position.
3. Adjust the sub brightness control so that background of the picture is just disappeared.
4. Adjust the sub contrast control so that normal contrast is obtained.

4.13 Color Purity and Vertical Centering Adjustment

For best results, it is recommended that the purity adjustment be made in the final receiver location. If the monitor will be moved, perform this adjustment with it facing east or west. The monitor must have been operating 15 minutes prior to this procedure and the faceplate of the CRT must be at room temperature.

The monitor is equipped with an automatic degaussing circuit. However, if the CRT shadow mask has become excessively magnetized, it may be necessary to degauss it with a manual coil. Do not switch the coil OFF while the raster shows any effect from the coil.

Purity magnets are used for color purity and vert. centering adjustment.

Purity adjustment procedure is as follows.

1. Set the brightness control to maximum.
2. Turn the green cut off control (VR252) on the neck board fully CCW.
Turn the red and blue cut off controls (VR253, VR251) fully CW.

3. Pull the deflection yoke backward so that the magenta belt will appear. (See Fig. 11)
4. Move the two purity magnets and bring the magenta belt to the mechanical center of the screen. (See Fig. 11)

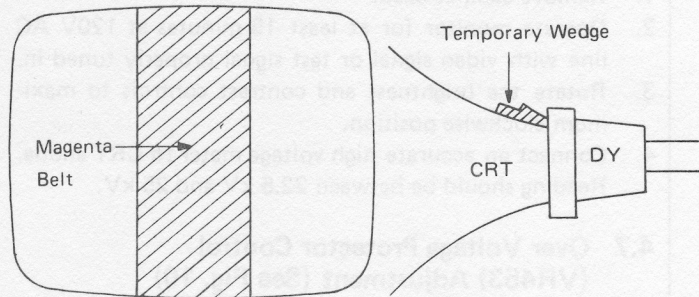

Fig. 11

5. Push the deflection yoke forward gradually and fix it at the place where the magenta screen becomes uniform throughout.
6. Turn the cut off control, and drive control and confirm that each color is uniform.
7. If the color is not uniform, re-adjust it by moving purity magnets slightly.
8. Move the pair of purity magnets at the same time (do not change the angle of the pair), and adjust the vertical center to center of screen.
9. Obtain the three colors and confirm whether white uniformity is balanced.
10. Insert the temporary wedge as shown in Fig. 11 and adjust the angle of deflection yoke.

4.14 Static Convergence Adjustment

A recently developed deflection yoke and electron guns construction has been used on this equipment in combination with in-line guns and black stripe screen to make a barrel-type magnetic-field distribution for vertical deflection and a pin-cushion-type magnetic field for horizontal deflection with which a self-converging system can be obtained. This type is different from conventional unity magnetic field distribution type deflection yoke. 4-pole magnets and 6-pole magnets are employed for static convergence instead of a convergence yoke.

1. A crosshatch signal should be connected to the video input terminal of the monitor.
2. Set the contrast and brightness knobs to obtain a visible screen.
3. A pair of 4-pole convergence magnets are provided and adjusted to converge the blue and red beams. When the pole opens to the left and right 45° symmetrically, the magnetic field maximizes. Red and blue beams move to the left and right oppositely (See Figs. 12- (a) and 12- (b)). Variation of the angle between the tabs adjusts the convergence of red and blue vertical lines.

When both 4-pole convergence magnet tabs are rotated as a pair, the convergence of the red and blue horizontal lines is adjusted.

- A pair of 6-pole convergence magnets are also provided and adjusted to converge the magenta (red + blue) to green beams.

When the pole opens to the left and right 30° symmetrically, the magnetic field is maximized. Red and blue beams both move to the left and right. (See Figs. 13-(c) and 13-(d)).

Variation of the opening angle adjusts the convergence of magenta to green vertical lines. When both 6-pole convergence magnet tabs are rotated as a pair, the convergence of magenta to green horizontal lines is adjusted.

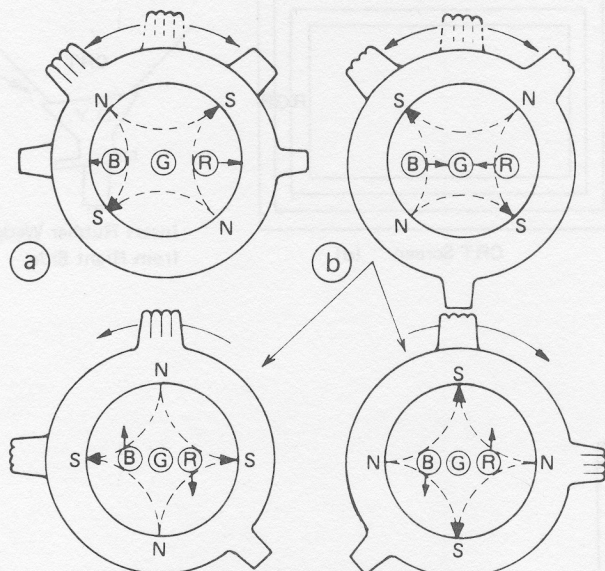

4-Pole Magnets and the Movement of Beams

Fig. 12

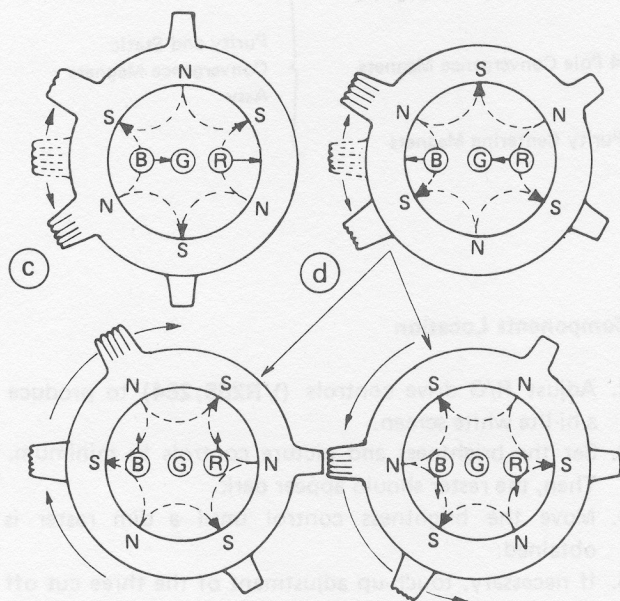

6-Pole Magnets and the Movement of Beams

Fig. 13

4.15 Precise Adjustment of Dynamic Convergence (See Figs. 14 and 15)

- Inject a crosshatch signal to the video input terminal.
- Set the contrast and brightness knobs to obtain a visible screen.
- Insert the temporary wedge and fix the deflection yoke so as to obtain the best circumference convergence. (See Fig. 15)

Note:

The temporary wedges may need to be moved during adjustments.

- Insert three rubber wedges to the position as shown in Fig. 14 to obtain the best circumference convergence.

Note:

- Tilting the angle of the yoke up and down adjusts the crossover of both vertical and horizontal red and blue lines. See Figs. 15(a) and 15(b).
- Tilting the angle of the yoke sideways adjusts the parallel convergence of both horizontal and vertical lines at the edges of the screen. See Figs. 15(c) and 15(d).
- Use three rubber wedges.
- The angle of each rubber wedge is shown in Fig. 14.
- After three rubber wedges with chloroprene rubber adhesive have been inserted, pull out the temporary wedge.

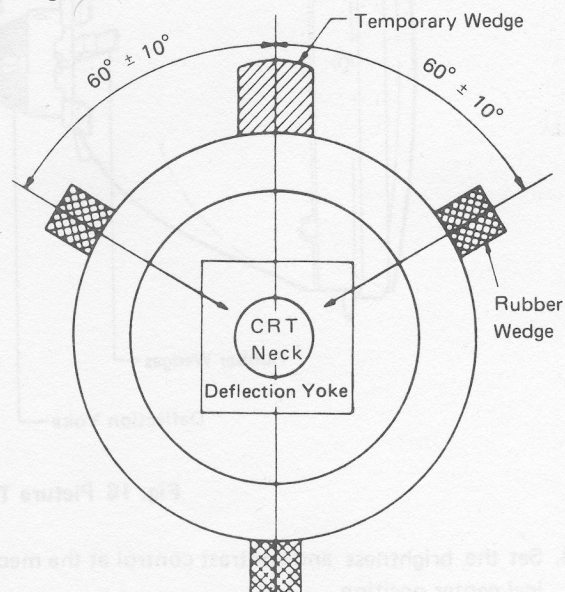

Fig. 14

4.16 Black and White Tracking

The purpose of this procedure is to optimize the picture tube to obtain a good black and white picture at all brightness levels, while at the same time achieving maximum usable brightness. Normal purity adjustment must precede this procedure.

- Set the Video mode switch to Digital RGB position.
- Connect the black signal to RGB input terminal.

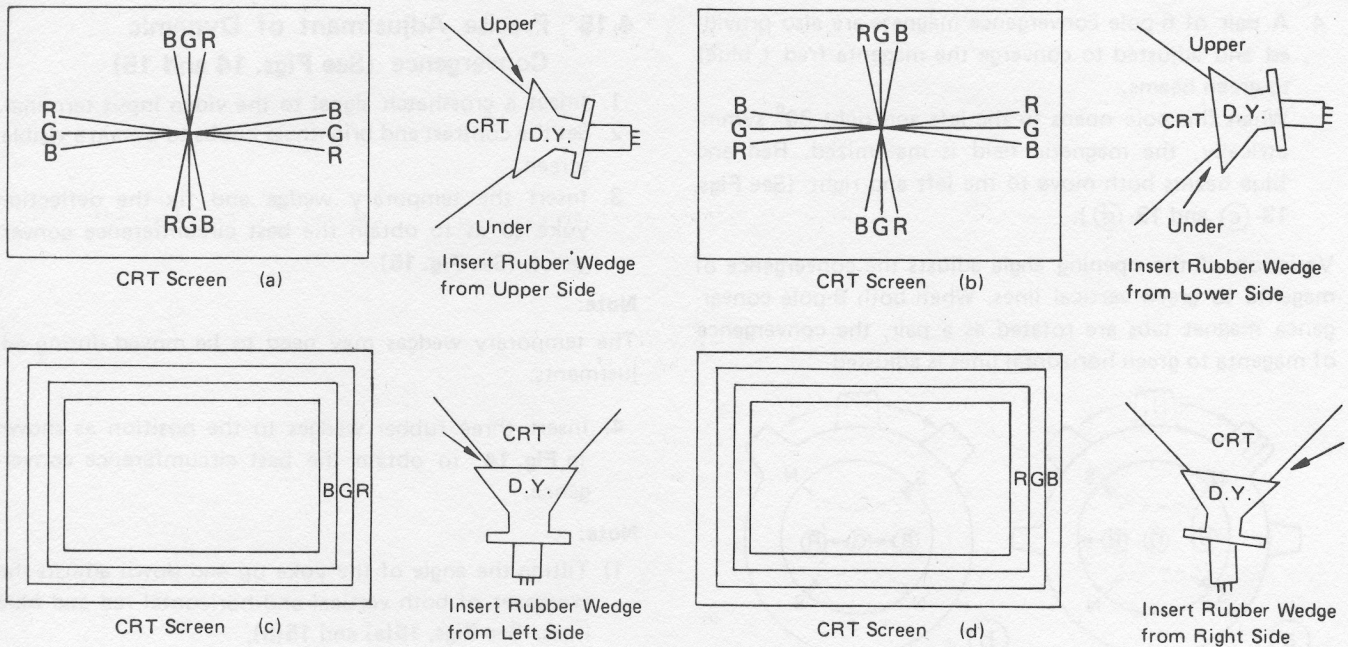

Fig. 15

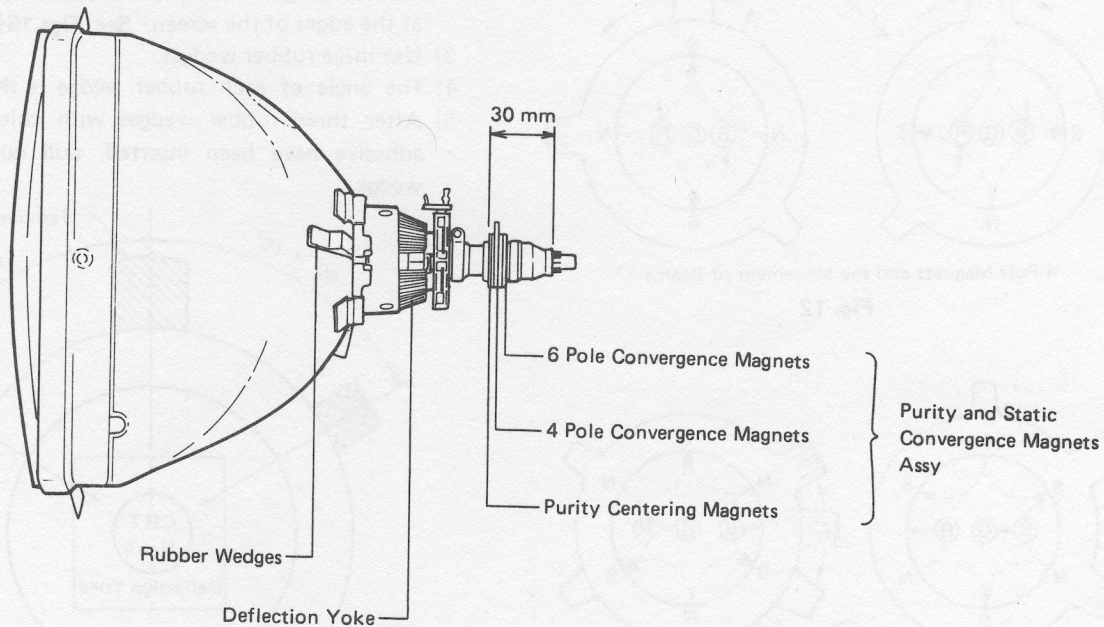

Fig. 16 Picture Tube Neck Components Location

3. Set the brightness and contrast control at the mechanical center position.
4. Rotate the red, green and blue cut off controls fully counter-clockwise.
5. Rotate the G. drive and R. drive controls to midrange.
6. Rotate screen VR fully counter-clockwise.
7. Short circuit TP401 and TP402 with a jumper clip to produce a horizontal line.
8. Slowly turn the screen control on FBT clockwise until color (colors) appears faintly on the screen.
9. Adjust each cut-off control so that color becomes lightest and horizontal lines are turned to white color.
10. Remove the jumper clip.
11. Receive the white signal.
12. Adjust R/G drive controls (**VR255, 254**) to produce a hi-lite white screen.
13. Set the brightness and picture controls to minimum. Then, the raster should appear dark.
14. Move the brightness control until a dim raster is obtained.
15. If necessary, touch-up adjustment of the three cut off controls to obtain best white uniformity on the CRT screen.
16. Set the brightness and picture controls at the mechanical center position. If necessary, adjust the R. drive and G. drive controls to produce a uniform black and white picture.

5. SERVICE INFORMATION

5.1 Rear Connection Panel

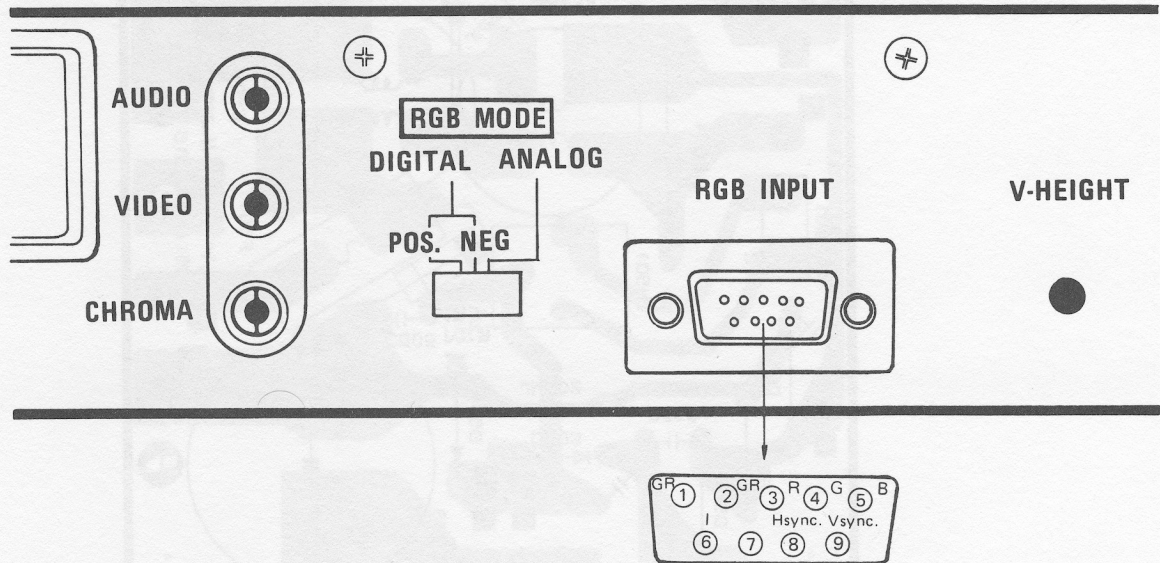

Fig. 17

Pin No.	DIGITAL POS.	DIGITAL NEG.	ANALOG
1	Ground	Ground	Ground
2	Ground	Ground	Ground
3	Red	Red	Red
4	Green	Green	Green
5	Blue	Blue	Blue
6	Intensity	Intensity	—
7	—	—	Sync.
8	H. Sync.	H. Sync.	—
9	V. Sync.	V. Sync.	—
Shell	Shield	Shield	Shield
Polarity	Video Positive Sync. Negative	Video Positive Sync. Negative	Video Positive Sync. Negative

POWER P.C. BOARD (5ASB)

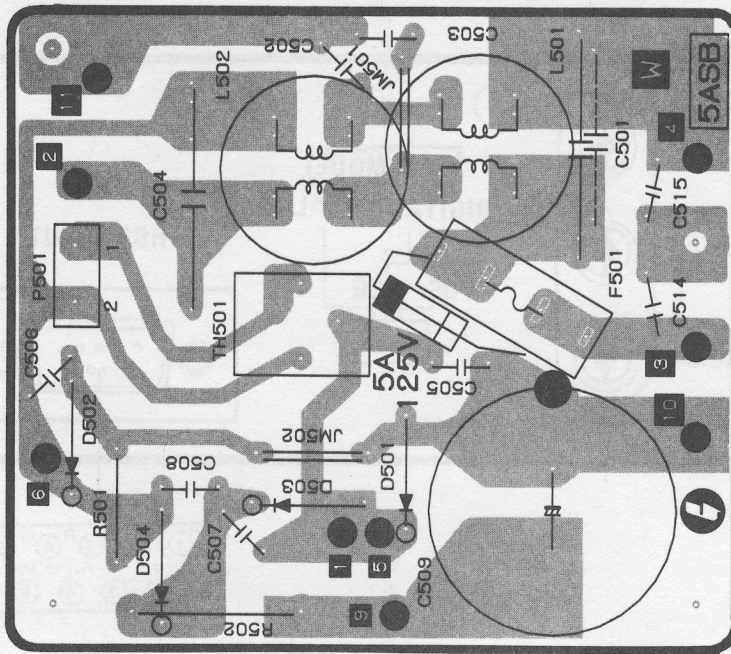

Fig. 18-a Top View

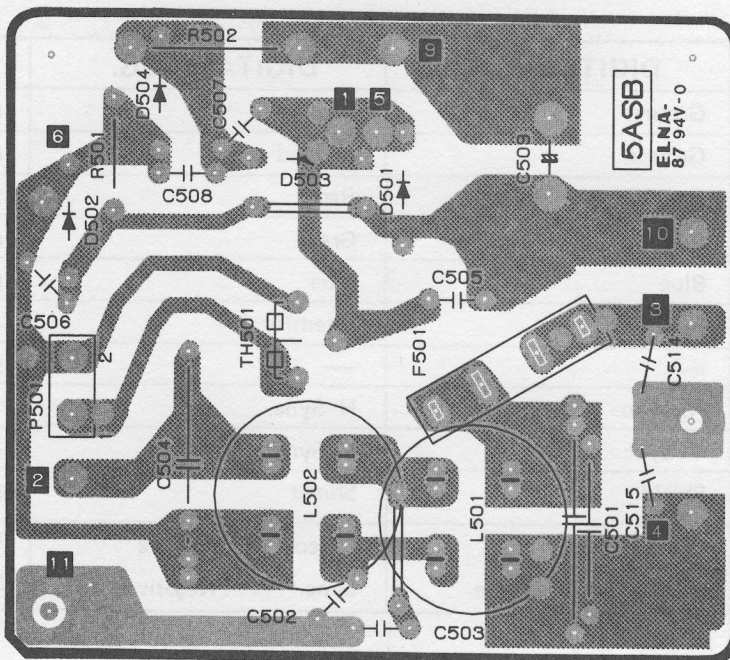

Fig. 18-b Bottom View

VIDEO P.C. BOARD (5BI)

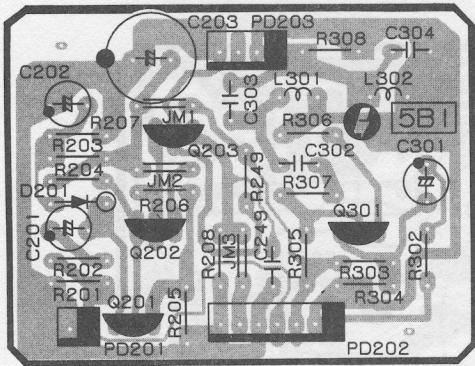

Fig. 20-a Top View

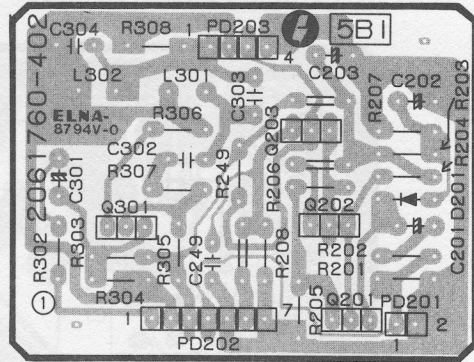

Fig. 20-b Bottom View

SWITCH P.C. BOARD (5ASF)

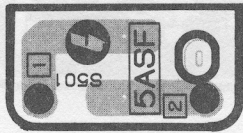

Fig. 21-a Top View



Fig. 21-b Bottom View

EARPHONE P.C. BOARD (5ASE)

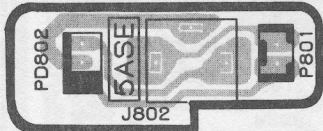

Fig. 22-a Top View

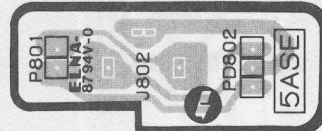

Fig. 22-b Bottom View

LED P.C. BOARD (5ASD)

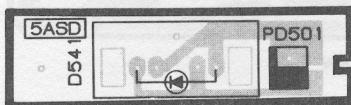

Fig. 23-a Top View

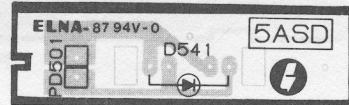
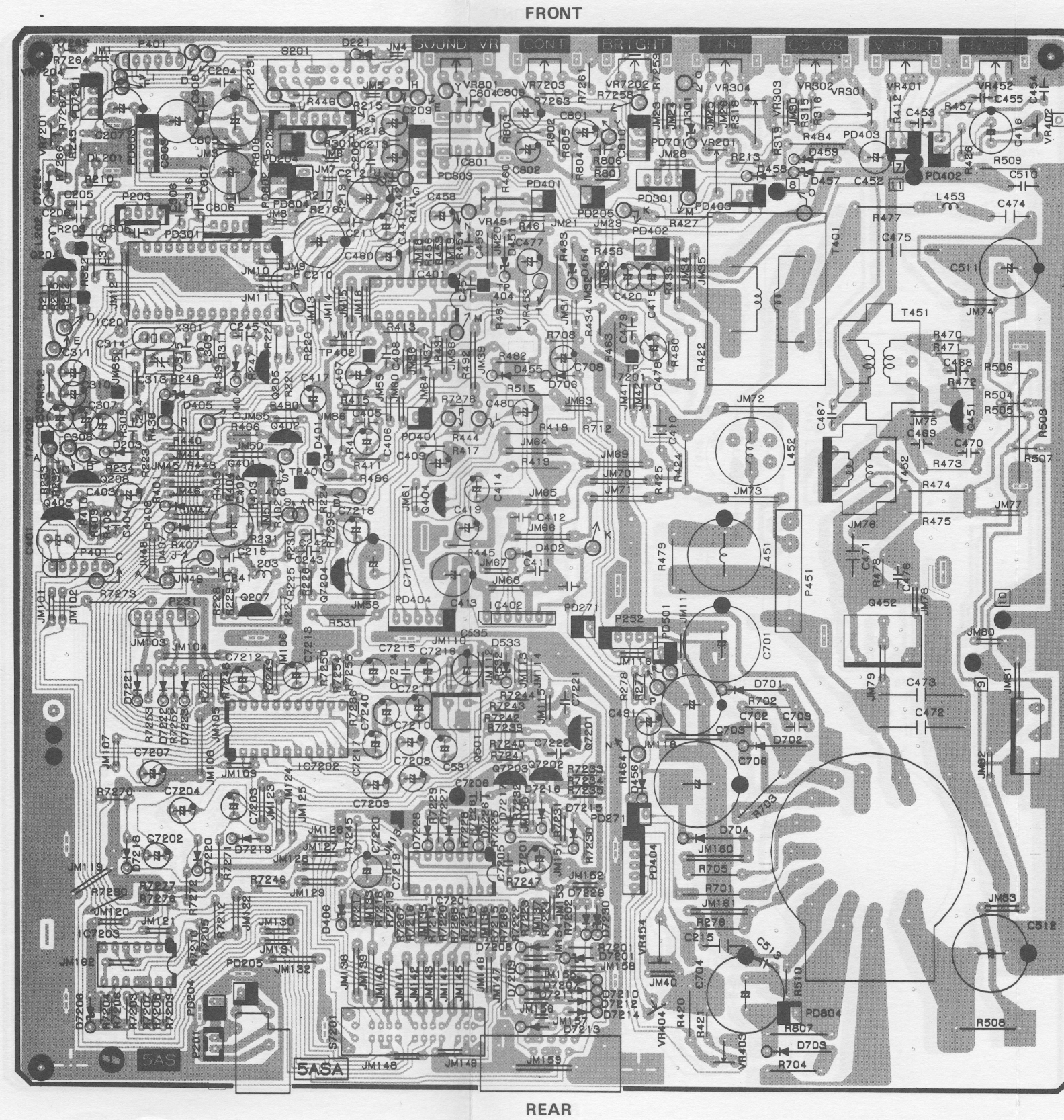

Fig. 23-b Bottom View

MAIN P.C. BOARD (5ASA)

Fig. 24-a Top View (Component Side)

CHASSIS NO. ECC-14256



A

B

C

D

E

1

2

3

4

5

6

7

Fig. 24-b Bottom View (Solder Side)

CHASSIS NO. ECC-14256

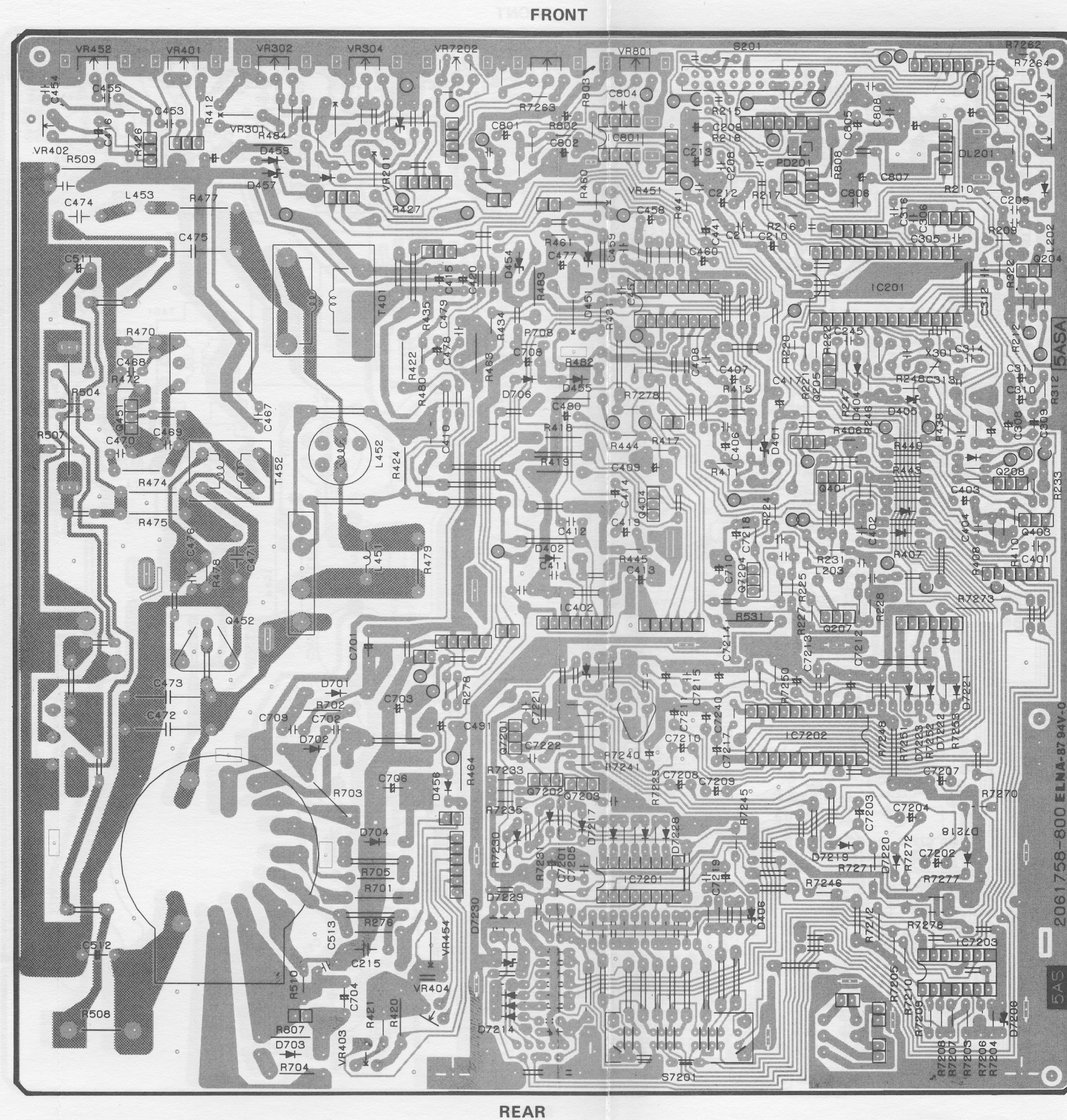

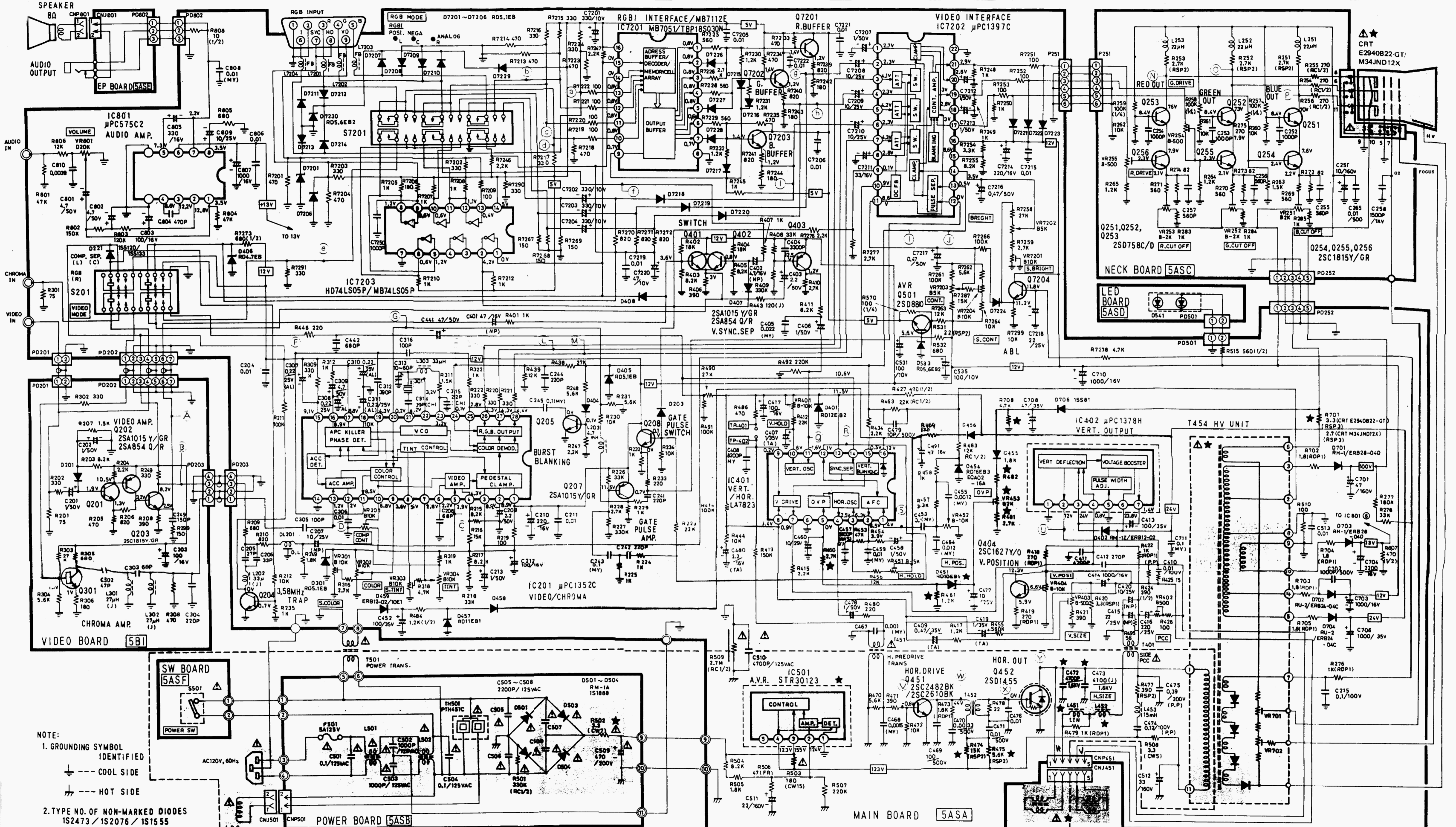

NOTE:
 1. GROUNDING SYMBOL IDENTIFIED
 --- COOL SIDE
 --- HOT SIDE

2. TYPE NO. OF NON-MARKED DIODES
 1S2473 / 1S2076 / 1S1555

3. TYPE NO. OF NON-MARKED TRANSISTORS
 2SC1815Y/GR, 2SC2458Y/GR
 2SC1740 Q/R

★ CRT
 E2940B22-GT/
 M34JND12X

LED BOARD
 5ASD

SW BOARD
 5ASF

POWER BOARD
 5ASB

MAIN BOARD
 5ASA

NECK BOARD
 5ASC

VIDEO BOARD
 5BJ

AUDIO BOARD
 5ASB

EP BOARD
 5ASE

BLOCK DIAGRAM

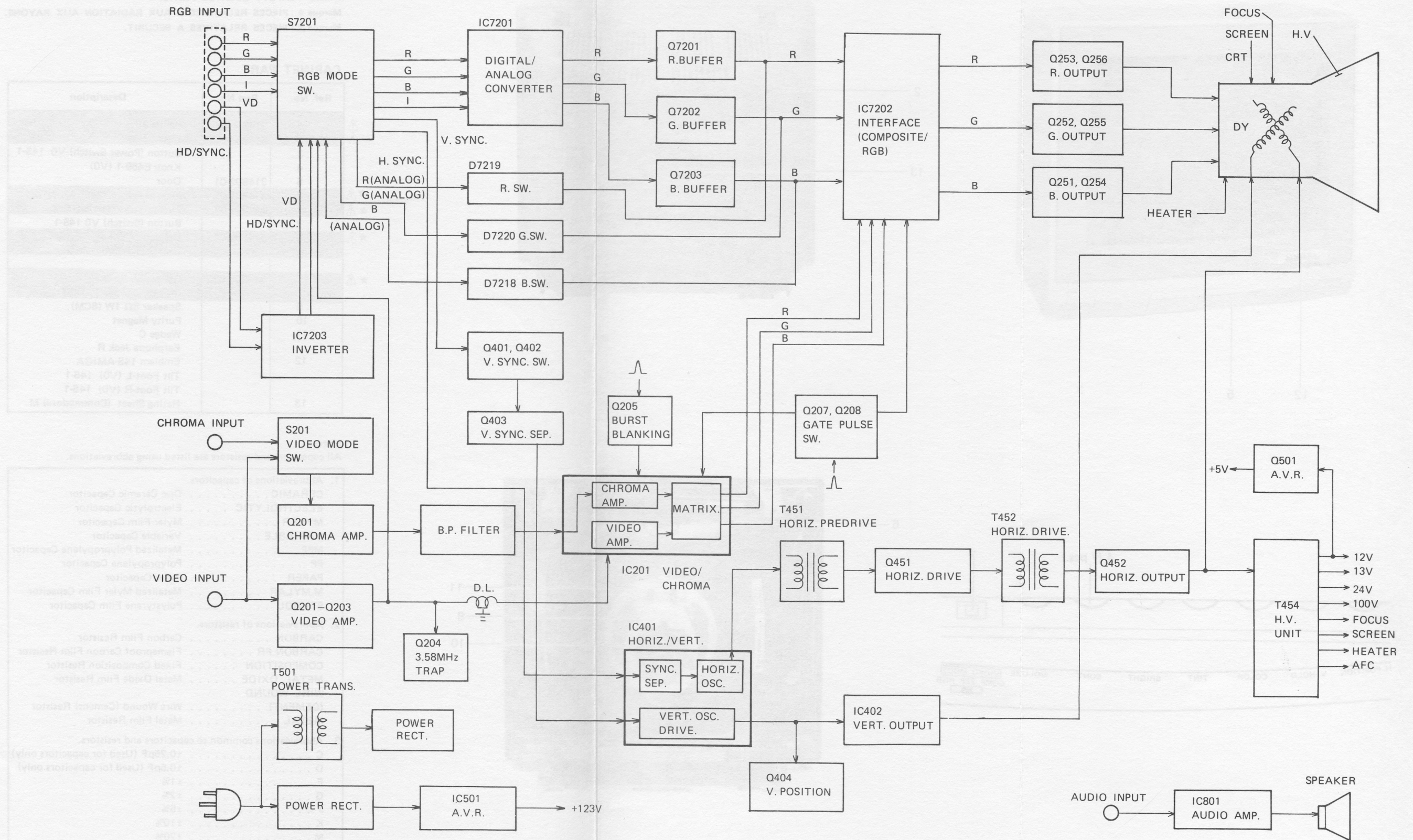

PARTS LIST

- ★ Mark : X-RAY RADIATION RELATED PARTS.
- ⚠ Mark : SAFETY RELATED PARTS.
- Marque ★ : PIECES RELATIVES A AUX RADIATION AUX RAYONS.
- Marque ⚠ : PIECES RELATIVES A SECURIT.

CABINET PART

Ref. No.	Part No.	Description
1	314800-01	Cabinet
2	314801-01	Rear Cover
3		Button (Power Switch)-V0 14S-1
4		Knob E459-1 (V0)
5	314802-01	Door
★ ⚠ 6	314804-01	Picture Tube E2940B22-GT (Y)
★ ⚠ 7	314804-02	Picture Tube M34JND12X
★ ⚠ 8	314805-01	Button (Switch) V0 14S-1
★ ⚠ 9		Deflection Yoke
		(For CRT E2940B22-GT)
★ ⚠ 10	314805-02	Deflection Yoke
		(For CRT M34JND12X)
11		Speaker 8Ω 1W (8CM)
12		Purity Magnet
13		Wedge C
		Earphone Jack R
		Emblem 14S-AMIGA
		Tilt Foot-L (V0) 14S-1
		Tilt Foot-R (V0) 14S-1
		Rating Sheet (Commodore)-M

Notes:

All capacitors and resistors are listed using abbreviations.

1. Abbreviations of capacitors.
 - CERAMIC Disc Ceramic Capacitor
 - ELECTROLYTIC Electrolytic Capacitor
 - MYLAR Mylar Film Capacitor
 - VARIABLE Variable Capacitor
 - MPP Metalized Polypropylene Capacitor
 - PP Polypropylene Capacitor
 - PAPER Paper Capacitor
 - M.MYLAR Metalized Mylar Film Capacitor
 - STYROL Polystyrene Film Capacitor
2. Abbreviations of resistors.
 - CARBON Carbon Film Resistor
 - CARBON FR Flameproof Carbon Film Resistor
 - COMPOSITION Fixed Composition Resistor
 - METAL OXIDE Metal Oxide Film Resistor
 - WIRE WOUND (CEMENT) Wire Wound (Cement) Resistor
 - METAL Metal Film Resistor
3. Abbreviations common to capacitors and resistors.
 - C ±0.25pF (Used for capacitors only)
 - D ±0.5pF (Used for capacitors only)
 - F ±1%
 - G ±2%
 - J ±5%
 - K ±10%
 - M ±20%
 - Z +80% -20% (Used for capacitors only)
 - P +100% -0% (Used for capacitors only)

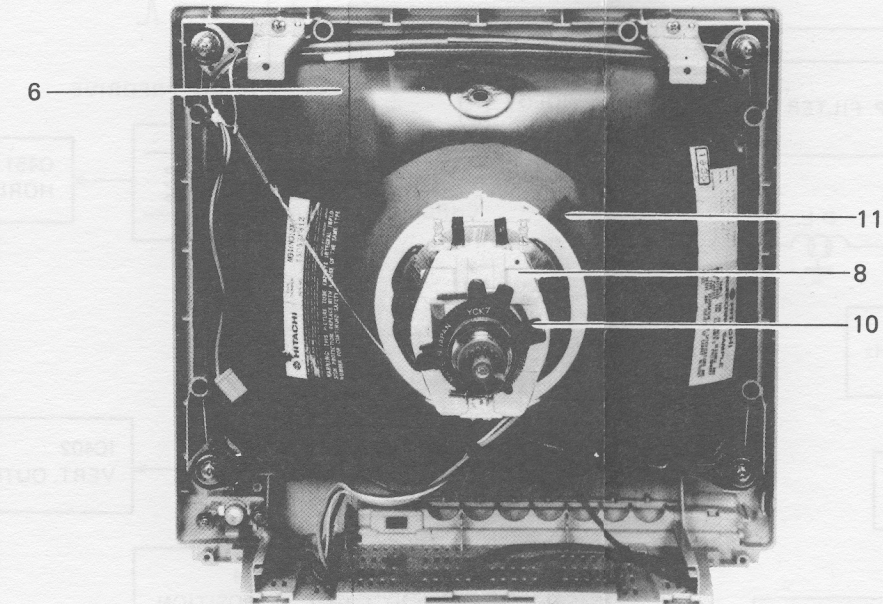
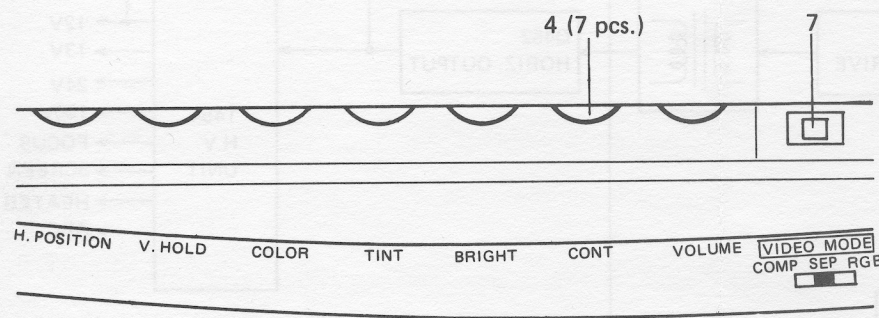
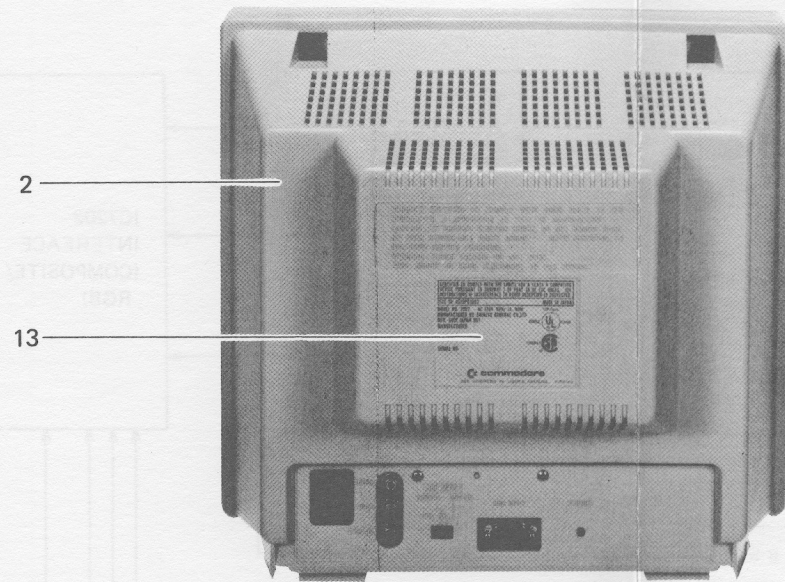
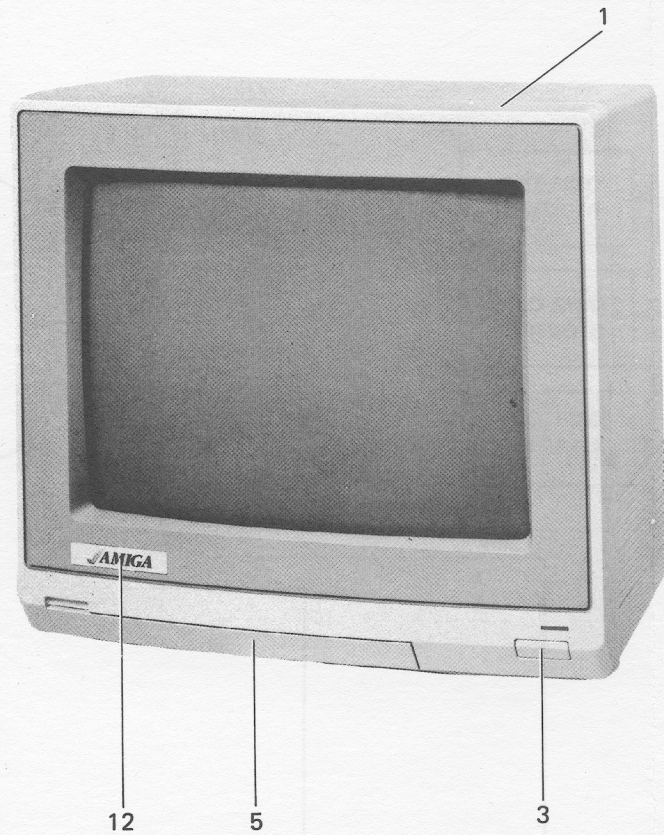

CAPACITORS

Ref. No.	Part No.	Description		
C201,202		Electrolytic	50V	1 μ F-M
C203		Electrolytic	16V	100 μ F-M
C204		Ceramic	50V	0.01 μ F-Z
C205		Ceramic	50V	27pF-J
C206		Ceramic	50V	33pF-J
C207		Electrolytic	25V	10 μ F-M
C208		Ceramic	50V	68pF-J
C209		Electrolytic	50V	2.2 μ F-M
C210		Electrolytic	16V	220 μ F-M
C211		Ceramic	50V	0.01 μ F-Z
C212		Electrolytic	16V	100 μ F-M
C213		Electrolytic	50V	1 μ F-M
C215		PP	200V	0.1 μ F-K
C241,242		Ceramic	50V	220pF-J
C243		Mylar	50V	0.1 μ F-K
C244		Ceramic	50V	220pF-J
C245		Mylar	50V	0.1 μ F-K
C251		Electrolytic	160V	10 μ F
C252~254		Ceramic	50V	1000pF-K
C255~257		Ceramic	50V	470pF-K
C258		Ceramic	2KV	1500pF-K
C265		Ceramic	500V	0.01 μ F-K
C301		Electrolytic	25V	10 μ F-M
C302		Ceramic	50V	47pF-J
C303		Ceramic	50V	68pF-J
C304		Ceramic	50V	220pF-J
C305		Ceramic	50V	100pF-J
C306		Ceramic	50V	0.01 μ F-Z
C307,308		Electrolytic	25V	0.22 μ F-M
C309		Electrolytic	50V	4.7 μ F-M
C310,311		Electrolytic	25V	0.22 μ F-M
C312		Ceramic	50V	390pF-K
C313		Variable Capacitor ECR-HA060G11		
C314		Ceramic	50V	39pF-J
C315		Ceramic	50V	22pF-J
C316		Ceramic	50V	100pF-J
C401		Electrolytic	25V	4.7 μ F
C403		Electrolytic	50V	2.2 μ F-M
C404		Ceramic	50V	3300pF-K
C405		Mylar	50V	0.022 μ F-K
C406		Electrolytic	50V	1 μ F-M
C407		Tantal	35V	1 μ F-K
C408		Mylar	50V	8200pF-K
C409		Tantal	35V	0.47 μ F-K
C410		PP	100V	0.01 μ F-K
C411		Ceramic	50V	4700pF-K
C412		Ceramic	50V	270pF-K
C413		Elec Small	35V	100 μ F-M
C414		Electrolytic	25V	1000 μ F-M
C415		Electrolytic	25V	22 μ F-M
C416		Electrolytic	25V	220 μ F-M
C417		Electrolytic	16V	100 μ F-M
C419		Tantal	35V	1 μ F-K
C420		Electrolytic	25V	10 μ F-M
C441		Electrolytic	50V	4.7 μ F-M
C442		Ceramic	50V	150pF-J
C452		Elec Small	35V	100 μ F-M
C453		Mylar	50V	0.1 μ F-K
C454		Mylar	50V	0.012 μ F-K
C455		Mylar	50V	1200pF-K
C457		Mylar	50V	5600pF-J

Ref. No.	Part No.	Description		
C458		Electrolytic	50V	1 μ F-M
C459		Mylar	50V	0.01 μ F-K
C460		Electrolytic	25V	10 μ F-M
C467		Mylar	50V	1000pF-K
C468		Mylar	50V	1500pF-K
C469		Ceramic	500V	100pF-K
C470		Ceramic	500V	3300pF-K
C471		Ceramic	500V	0.01 μ F-K
★ C472	314818-01	PP	1.6KV	DC4700pF-J
★ C473	314828-01	PP	1.6KV	DC4100pF-J
C474		PP	100V	0.12 μ F-K
C475		PP	200V	0.39 μ F-K
C476		Ceramic	50V	0.01 μ F-Z
C477		Electrolytic	25V	10 μ F-M
C478		Electrolytic	50V	1 μ F-M
C479		Ceramic	500V	10pF-D
C480		Tantal	16V	2.2 μ F-K
C491		Electrolytic	16V	47 μ F-M
△ C501	314819-01	MPP	125V	0.1 μ F-M
△ C502,503	314829-01	Ceramic	125V	1000pF-K
△ C504	314830-01	MPP	125V	0.1 μ F-M
△ C505~508	314815-01	Ceramic	125V	2200pF-M
△ C509	314817-01	Electrolytic	200V	470 μ F
△ C510	314816-01	Ceramic	125V	4700pF-P
C511		Electrolytic	160V	22 μ F
C512		Electrolytic	160V	33 μ F
C513		Ceramic	50V	0.01 μ F-Z
C531,535		Electrolytic	10V	100 μ F-M
C701		Electrolytic	160V	47 μ F
C702		Ceramic	500V	1000pF-K
C703		Electrolytic	16V	1000 μ F
C704		Electrolytic	16V	2200 μ F-M
C706		Electrolytic	35V	1000 μ F-M
C708		Electrolytic	35V	47 μ F-M
C710		Electrolytic	16V	1000 μ F
C711		Mylar	50V	0.1 μ F-K
C801,802		Electrolytic	50V	4.7 μ F-M
C803		Electrolytic	16V	100 μ F-M
C804		Ceramic	50V	470pF-K
C805		Electrolytic	16V	330 μ F-M
C806		Ceramic	50V	0.01 μ F-Z
C807		Electrolytic	16V	1000 μ F
C808		Mylar	50V	0.1 μ F-K
C809		Electrolytic	25V	10 μ F-M
C810		Mylar	50V	3900pF-K
C7201~7204		Elec Small	10V	330 μ F-M
C7205		Ceramic	50V	0.01 μ F-Z
C7207		Electrolytic	50V	1 μ F-M
C7208~7210		Electrolytic	25V	10 μ F-M
C7211		Electrolytic	16V	33 μ F-M
C7212~7213		Electrolytic	50V	1 μ F-M
C7214		Elec Small	16V	220 μ F-M
C7215		Ceramic	50V	0.01 μ F-Z
C7216,7217		Electrolytic	50V	0.47 μ F-M
C7218		Electrolytic	25V	22 μ F-M
C7219		Ceramic	50V	0.01 μ F-Z
C7220		Electrolytic	10V	470 μ F-M
C7221,7222		Ceramic	50V	0.01 μ F-Z

Ref. No.	Part No.	Description		
C7250		Ceramic	50V	1000pF-K
C7255~ 7257		Ceramic	50V	680pF-K

RESISTORS

R201		Carbon	1/6W	75Ω-J
R202		Carbon	1/6W	330Ω-J
R203		Carbon	1/6W	8.2KΩ-J
R204		Carbon	1/6W	2.2KΩ-J
R205		Carbon	1/6W	470Ω-J
R206		Carbon	1/6W	820Ω-J
R207		Carbon	1/6W	1.5KΩ-J
R208		Carbon	1/6W	390Ω-J
R209		Carbon	1/6W	680Ω-J
R210		Carbon	1/6W	820Ω-J
R211		Carbon	1/6W	100KΩ-J
R212		Carbon	1/6W	10KΩ-J
R215		Carbon-F	1/6W	8.2KΩ-J
R216		Carbon-F	1/6W	15KΩ-J
R217		Carbon-F	1/6W	8.2KΩ-J
R218		Carbon-F	1/6W	33KΩ-J
R219		Carbon-F	1/6W	100Ω-J
R220		Carbon-F	1/6W	330Ω-J
R221,222		Carbon	1/6W	330Ω-J
R223		Carbon	1/6W	22KΩ-J
R224,225		Carbon	1/6W	1KΩ-J
R226		Carbon	1/6W	33KΩ-J
R227		Carbon	1/6W	330KΩ-J
R228		Carbon	1/6W	2.7KΩ-J
R229		Carbon	1/6W	1KΩ-J
R230		Carbon	1/6W	10KΩ-J
R231		Carbon	1/6W	5.6KΩ-J
R232		Carbon	1/6W	1KΩ-J
R233		Carbon	1/6W	220Ω-J
R234		Carbon	1/6W	10KΩ-J
R235		Carbon	1/6W	1KΩ-J
R245		Carbon-F	1/6W	1.8KΩ-J
R247		Carbon	1/6W	2.2KΩ-J
R248		Carbon	1/6W	5.6KΩ-J
R249		Carbon	1/6W	330Ω-J
R251~253		Metal Oxide	2W	2.7KΩ-J
R254~256		Composition	1/2W	270Ω-K
R257~259		Carbon	1/4W	100KΩ-J
R260~262		Carbon	1/6W	10KΩ-J
R263		Carbon	1/6W	1.5KΩ-J
R264,265		Carbon	1/6W	1.2KΩ-J
R269~271		Carbon	1/6W	560Ω-J
R272~274		Carbon	1/6W	82Ω-J
R275		Carbon	1/6W	270Ω-J
R276		Carbon	1W	1KΩ-J
R277		Carbon	1/6W	180KΩ-J
R278		Carbon	1/6W	33KΩ-J
R280~282		Carbon-F	1/6W	10KΩ-J
R283~285		Carbon-F	1/6W	1KΩ-J
R301		Carbon-F	1/6W	75Ω-J
R302		Carbon	1/6W	330Ω-J
R303		Carbon	1/6W	27KΩ-J

Ref. No.	Part No.	Description		
R304		Carbon	1/6W	5.6KΩ-J
R305		Carbon	1/6W	680Ω-J
R306		Carbon	1/6W	180Ω-J
R307		Carbon	1/6W	560Ω-J
R308		Carbon	1/6W	470Ω-J
R309		Carbon	1/6W	330KΩ-J
R311		Carbon	1/6W	1.5KΩ-J
R312		Carbon	1/6W	1KΩ-J
R316		Carbon	1/6W	2.7KΩ-J
R318		Carbon	1/6W	4.7KΩ-J
R319,322, 401		Carbon	1/6W	1KΩ-J
R402		Carbon	1/6W	18KΩ-J
R403		Carbon	1/6W	8.2KΩ-J
R404		Carbon	1/6W	18KΩ-J
R405		Carbon	1/6W	8.2KΩ-J
R406		Carbon	1/6W	680Ω-J
R407		Carbon	1/6W	1KΩ-J
R408		Carbon	1/6W	33KΩ-J
R409		Carbon	1/6W	330KΩ-J
R410		Carbon	1/6W	2.7KΩ-J
R411		Carbon	1/6W	8.2KΩ-J
R412		Carbon	1/6W	22KΩ-J
R413		Carbon	1/6W	150KΩ-J
R414		Carbon	1/6W	100KΩ-J
R415		Carbon	1/6W	2.2KΩ-J
R417		Carbon	1/6W	1.2KΩ-J
R418,419		Carbon	1W	270Ω-J
R420		Carbon	1W	3.3Ω-J
R421		Carbon	1/6W	390Ω-J
R422		Carbon	1W	1KΩ-J
R424		Carbon	1/2W	390Ω-J
R425		Carbon	1/6W	15Ω-J
R426		Carbon	1/6W	100Ω-J
R427		Carbon	1/2W	470Ω-J
R434		Carbon	1/6W	2.2KΩ-J
R438		Carbon	1/6W	27KΩ-J
R439		Carbon	1/6W	12KΩ-J
R443		Carbon	1/6W	120Ω-J
R444		Carbon	1/6W	10KΩ-J
R445		Carbon	1/6W	560KΩ-J
R446		Carbon	1/6W	220Ω-J
R453		Carbon	1/6W	47KΩ-J
R454		Carbon	1/6W	3.9KΩ-J
R456		Carbon	1/6W	12KΩ-J
R457		Carbon	1/6W	3.3KΩ-J
R458		Carbon	1/6W	1KΩ-J
★ R460	314831-01	Carbon	1/6W	2.7KΩ-J
★ R461	314832-01	Carbon	1/6W	1.2KΩ-J
R463		Composition	1/2W	22KΩ-K
R464		Carbon	1/2W	820Ω-J
R470		Carbon	1/6W	5.6KΩ-J
R471		Carbon	1/6W	390Ω-J
R472		Carbon	1/6W	10KΩ-J
R473		Carbon	1W	1.8KΩ-J
★ R474	314820-01	Metal Oxide	2W	15KΩ-J
★ R475	314833-01	Metal Oxide	2W	5.6KΩ-J
R477		Metal Oxide	2W	390Ω-J
R478		Carbon	1/6W	22Ω-J
R479		Carbon	1W	1KΩ-J

Ref. No.	Part No.	Description
R480		Carbon 1/6W 220Ω-J
★ R481	314834-01	Carbon 1/6W 2.7KΩ-J
★ R482	314835-01	Carbon 1/6W 1.8KΩ-J
R483		Composition 1/2W 12KΩ-K
R484		Carbon 1/2W 1.2KΩ-J
R486		Carbon 1/6W 470Ω-J
R490		Carbon 1/6W 27KΩ-J
R491		Carbon 1/6W 100KΩ-J
R492		Carbon 1/6W 220KΩ-J
R495		Carbon 1/6W 56Ω-J
△ R501	314821-01	Composition 1/2W 330KΩ-K
★ △ R502	314823-01	Wire Wound 7W 3.3Ω-J Cement
△ R503	314824-01	Wire Wound 15W 180Ω-J Cement
R504		Carbon 1/6W 8.2KΩ-J
R505		Carbon 1/6W 1.8KΩ-J
R506		Carbon-F 1/6W 47Ω-J
R507		Carbon 1/6W 220KΩ-J
R508		Wire Wound 5W 3.3Ω-K Cement
△ R509	314822-01	Composition 1/2W 2.7MΩ-K
R510		Carbon 1/6W 100Ω-J
R515		Carbon 1/2W 560Ω-J
R531		Metal Oxide 2W 22Ω-J
R532		Carbon 1/6W 680Ω-J
R570		Carbon 1/4W 100Ω-J
★ R701	314836-01	Metal Oxide 3W 3.3Ω (When CRT E2940B22-GT is used)
★ R701	314837-01	Metal Oxide 3W 2.7Ω (When CRT M34JND 12X is used)
R702~705		Carbon 1W 1.8Ω-J
★ R708	314838-01	Carbon 1/6W 4.7KΩ-J
R801		Carbon 1/6W 47KΩ-J
R802		Carbon 1/6W 150KΩ-J
R803		Carbon 1/6W 120KΩ-J
R804		Carbon 1/6W 47KΩ-J
R805		Carbon 1/6W 680Ω-J
R806		Carbon 1/6W 12KΩ-J
R807		Carbon 1/2W 470Ω-J
R808		Carbon 1/2W 10Ω-J
R7201		Carbon 1/6W 470Ω-J
R7202,7203		Carbon 1/6W 330Ω-J
R7204		Carbon 1/6W 470Ω-J
R7205		Carbon 1/6W 1KΩ-J
R7206		Carbon 1/6W 100Ω-J
R7207,7208		Carbon 1/6W 1KΩ-J
R7209		Carbon 1/6W 100Ω-J
R7210,7212		Carbon 1/6W 1KΩ-J
R7213,7214		Carbon 1/6W 470Ω-J
R7215~7217		Carbon 1/6W 330Ω-J
R7218		Carbon 1/6W 470Ω-J
R7219~7222		Carbon 1/6W 100Ω-J
R7223		Carbon 1/6W 470Ω-J
R7224		Carbon 1/6W 330Ω-J
R7225		Carbon 1/6W 560Ω-J
R7226		Carbon 1/6W 2.7KΩ-J
R7228,7229		Carbon 1/6W 560Ω-J
R7230~7232		Carbon 1/6W 1.2KΩ-J

Ref. No.	Part No.	Description
R7233~7235		Carbon 1/6W 470Ω-J
R7239~7241		Carbon 1/6W 820Ω-J
R7242~7244		Carbon 1/6W 180Ω-J
R7245		Carbon 1/6W 1KΩ-J
R7246,7247		Carbon 1/6W 2.2KΩ-J
R7248~7250		Carbon 1/6W 1KΩ-J
R7251~7253		Carbon 1/6W 100Ω-J
R7254		Carbon 1/6W 3.3KΩ-J
R7255		Carbon 1/6W 8.2KΩ-J
R7258		Carbon-F 1/6W 27KΩ-J
R7259		Carbon-F 1/6W 2.7KΩ-J
R7261		Carbon 1/6W 100KΩ-J
R7262		Carbon-F 1/6W 5.6KΩ-J
R7263		Carbon 1/6W 12KΩ-J
R7264		Carbon-F 1/6W 10KΩ-J
R7266		Carbon 1/6W 100KΩ-J
R7267~7269		Carbon 1/6W 150Ω-J
R7270~7272		Carbon 1/6W 820Ω-J
R7273		Carbon 1/2W 680Ω-J
R7276		Carbon 1/6W 2.2KΩ-J
R7277		Carbon 1/6W 2.7KΩ-J
R7278		Carbon 1/6W 4.7KΩ-J
R7287		Carbon 1/6W 15KΩ-J
R7290,7291		Carbon 1/6W 330Ω-J
R7299		Carbon 1/6W 10KΩ-J

THERMISTOR

△ TH501	314839-01	PTH451C38BF7R0N140
---------	-----------	--------------------

CONTROLS

VR201		Variable 10KΩ-B
VR251~253		Variable 2KΩ-B
VR254,255		Variable 500Ω-B
VR301		Variable 10KΩ-B
VR302		Variable 10KΩ-B
VR303		Variable 10KΩ-B
VR304		Variable 10KΩ-B
VR401		Variable 10KΩ-B
VR402		Variable 500Ω-B
VR403		Variable 500Ω-B
VR404		Variable 10KΩ-B
VR451		Variable 5KΩ-B
VR452		Variable 10KΩ-B
★ VR453	314840-01	Variable 2KΩ-B
VR801		Variable 20KΩ-D
VR7201		Variable 10KΩ-B
VR7202		Variable 5KΩ-B
VR7203		Variable 5KΩ-B
VR7204		Variable 10KΩ-B

INDUCTORS

COMPLETE MODULES AND ASSY

Ref. No.	Part No.	Description
★ ⚠ T454	314807-01 314841-01	HV-Unit MA-1 Coil 147NDB (Degaussing)
DL201		Delay Line B1
L202		Coil 33μH±5% (Peaking-TP)
L203		Coil G 4.7MH±5% (RF Choke)
L251		Coil 22μH±5% (Peaking-TP)
L252		Coil 22μH±5% (Peaking-TP)
L253		Coil 22μH±5% (Peaking-TP)
L301		Coil 27μH±5% (Peaking-TP)
L302		Coil 27μH±5% (Peaking-TP)
L303		Coil 33μH±5% (Peaking-TP)
★ L451	314813-01	Coil J-1 (Horiz.-Lin)
★ L452	314809-01	Coil Q (Horiz.-Size)
L453		Coil 15MH±5% (RF Choke)
⚠ L501	314810-01	Line Filter X-2
⚠ L502	314842-01	Line Filter X-1
⚠ T401	314812-01	Transformer (Side-PC) V-1
⚠ T451	314814-01	Transformer (H-Insulation)
T452		Transformer (Horiz-Drive)
⚠ T501	314811-01	Transformer (Power)
X301		Crystal Oscillator 3579.545 KHz

Ref. No.	Part No.	Description
		CRT Grounding Wire 147NDBAZ-C
		P.C. Board Assy (MAIN) 5ASA
		P.C. Board Assy (POWER) 5ASC
		P.C. Board Assy (NECK) 5ASB
		P.C. Board Assy (SWITCH) 5ASE
		P.C. Board Assy (LED) 5ASD
		P.C. Board Assy (EP) 5ASF

MISCELLANEOUS

⚠	314827-01	Socket CRT AG
		Jack Phono-Pin 3P
⚠		Plug-3P Power Supply
		Plug-9P D-Sub
		Interface Cable-I
		Cable A L170
		Spring F (Grounding)
		Spring (Button) 14S
		LED Holder-V0 14S-1
		Tilt Holder-L V0 14S
		Tilt Holder-R V0 14S
		Holder (SP) V0 14S
⚠	314803-01	Power Cord 3P
		Plug 5P-H, PCB
CNP451		Plug 2P-H, PCB
CNP801		Plug 2P-TL, PCB
⚠ F501	314825-01	Fuse 5.0A 125V
		Fuse Holder Single E (For F501)
P801		Plug 2P-TLL, PCB
S201		Switch, Slide 30VDC 0.1A 4P3T
⚠ S501	314844-01	Switch, Push (Power) PCB TV-3 1P1T
S7201		Switch, Slide 15VDC 0.5A 6P3T
⚠	314843-01	Plug Power Supply 3P

SEMICONDUCTORS

Integrated circuit

Ref. No.	Part No.	Type	Substitutes	Function
IC201		μPC1352C		Video
IC401		LA7823		Vert./Horiz.
IC402		μPC1378H		Vert. Output
★ IC501	314806-01	STR30123		A.V.R.
IC801		μPC575C2		Audio Amp.
IC7201		MB7051G3	TBP18S03ONG3	RGBI Interface
IC7202		μPC1397C		Video Interface
IC7203		HD74LS05P	MB74LS05P	

Transistors

Q201		2SC1815Y	2SC2458Y 2SC2458GR 2SC1815GR	Video Amp.
Q202		2SA1015Y	2SA1015GR 2SA854Q 2SA854R	Video Amp.
Q203		2SC1815Y	2SC2458Y 2SC2458GR 2SC1815GR	Video Amp.
Q204		2SC1815Y	2SC2458Y 2SC2458GR 2SC1815GR	3,58MHz Trap
Q205		2SC1815Y	2SC2458Y 2SC2458GR 2SC1815GR	Burst Blanking
Q207		2SA1015Y	2SA1015GR	Gate Pulse Amp.
Q208		2SC1815Y	2SC2458Y 2SC2458GR 2SC1815GR	Gate Pulse Switch
Q251		2SD758-04C	2SD758-04D	Blue Out
Q252		2SD758-04C	2SD758-04D	Green Out
Q253		2SD758-04C	2SD758-04D	Red Out

Ref. No.	Part No.	Type	Substitutes	Function
Q254		2SC1815Y	2SC1815GR	
Q255		2SC1815Y	2SC1815GR	
Q256		2SC1815Y	2SC1815GR	
Q301		2SC1815Y	2SC2458Y 2SC2458GR 2SC1815GR	Chroma Amp.
Q401		2SC1815Y	2SC2458Y 2SC2458GR 2SC1815GR	Switch
Q402		2SC1815Y	2SC2458Y 2SC2458GR 2SC1815GR	V. Sync. Sep.
Q403		2SA1015Y	2SA1015GR	
Q404		2SC1627Y	2SC1627-O	V. Position
Q451		2SC2482BK	2SC2610BK	Horiz. Drive
Q452		2SD1455-04		Horiz. Out
Q501		2SD880YLBGL2	2SD880GRLBGL2	AVR
Q7201		2SC1815Y	2SC2458Y 2SC2458GR 2SC1815GR	R. Buffer
Q7202		2SC1815Y	2SC2458Y 2SC2458GR 2SC1815GR	G. Buffer
Q7203		2SC1815Y	2SC2458Y 2SC2458GR 2SC1815GR	B. Buffer
Q7204		2SC1815Y	2SC2458Y 2SC2458GR 2SC1815GR	ABL

DIODES

Ref. No.	Part No.	Type	Substitutes	Function
		SLP-171D		
D201,203		1S2473	1S1555 1S2076-27	
D221		1SS120		
D301		RD5.1EB		
D401		RD12EB2		
D402		ERB12-02 RM-1Z	RM-1Z	
D404		1S2473	1S1555 1S2076-27	
D405		RD5.1EB		
D406		RD4.7EB		
D407,408		1S2473	1S1555 1S2076-27	
D451		RD10EB1		
D454		RD16EB3	EQA02-16A	
D455,456		1S2473	1S1555 1S2076-27	
D457		RD11EB1		
D458		1S2473	1S1555 1S2076-27	
D459		ERB12-02	10E1	
⚠ D501~504	314808-01	RM-1A	1S1888	
D533		RD5.6EB2		
D701		RH-1	ERB28-04D	
D702		ERB24-04C	RU-2	
D703		RH-1	ERB28-04D	
D704		ERB24-04C	RU-2	
D706		1SS81		

Ref. No.	Part No.	Type	Substitutes	Function
D7201		RD5.1EB		
D7206		RD5.1EB		
D7207~7224, 7226~7229		1S2473	1S1555 1S2076-27	
D7230		RD5.6EB2		



Computer Systems Division
1200 Wilson Drive
West Chester, PA 19380